

PENNSYLVANIA
VEGETABLE GROWERS

NEWS

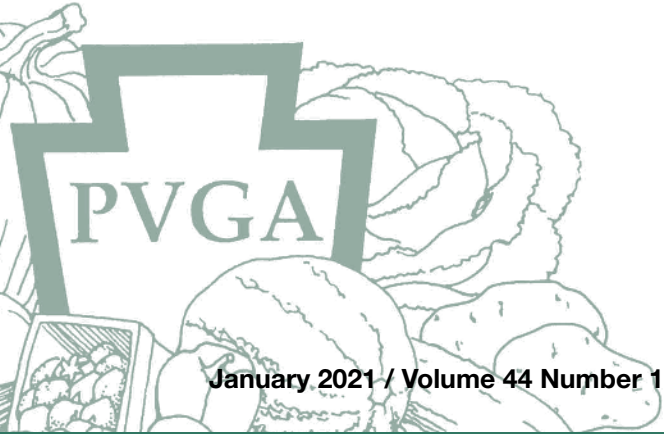

January 2021 / Volume 44 Number 1

for the commercial vegetable, potato and berry grower



2021 Buyers' Guide



GENERAL



*Pennsylvania
Vegetable Growers
Association*

*An association of
commercial vegetable,
potato and berry growers.*

President

Brian Campbell '21
Berwick

First Vice President

Rita Resick '23
Somerset

Second Vice President

Peter Flynn '21
West Chester

Secretary-Treasurer

William Reynolds '22
Waynesboro

Past President

Jonathan Strite '22
Harrisburg

Directors

Robert Amsterdam '21
Mechanicsburg

Tina Forry '22
Palmyra

Christopher Harner '23
State College

Barron Hetherington '22
Ringtown

Alan Kemmerer '22
Berwick

Arthur King '21
Valencia

Amy Metrick '21
Butler

Michael Orzolek '21
State College

Christopher Powell '23
Strasburg

John Shenk '23
Lititz

Robert Shenot '22
Wexford

Jeffrey Stoltzfus '23
Arglen

Mark Troyer '21
Waterford

Joel Weaver '23
Windber

Executive Director
William Troxell
Richfield

Dear Pennsylvania Grower

This special edition of the Pennsylvania Vegetable Growers News, the monthly newsletter of the Pennsylvania Vegetable Growers Association, has been prepared as a source book of information for you, the Pennsylvania grower. We have listed various vendors of equipment, supplies and services who deal with Pennsylvania growers. Keep this booklet handy to refer to throughout the year.

We also ask you to consider joining the Pennsylvania Vegetable Growers Association. If you are a vegetable, potato or berry grower, you should belong to the organization that represents your industry. Founded in 1926, PVGA has been serving growers like you for the past 94 years making 2021 our 95th anniversary. Your membership will strengthen the Association's position as the official voice of the vegetable, potato and berry industries and will also provide numerous benefits to you.

For example, each year the Association co-sponsors the Mid-Atlantic Fruit and Vegetable Convention in Hershey. While this year's Mid-Atlantic Convention is of necessity a virtual event from February 8 to 11, it designed to continue the tradition of providing several days of concurrent educational sessions on processing vegetables, fresh market vegetables, potatoes, small fruits, direct marketing, and organic vegetables. The Mid-Atlantic Convention has become one of the premier grower meetings in the northeast and beyond. As a member of the Association, you help make this convention possible. PVGA normally also sponsors regional grower meetings and farm market tours and hopes these grower events can resume later this year.

As a member, you will receive monthly subscriptions to this newsletter, the **Pennsylvania Vegetable Grower News**, to keep you informed on what is happening in the vegetable, potato and berry industries. PVGA members also receive free subscriptions to the **American Vegetable Grower** and the **Vegetable Growers News**.

Last year, the Association gave over \$61 per member of the Association or a total of \$60,000 to researchers to sponsor practical vegetable research. This was made possible through the Association's food booth at the Pennsylvania Farm Show and Convention profits. The food booth also helps to promote the vegetable and berry products you produce.

PVGA represents the interests of the vegetable, potato and berry industries on both state and federal issues. The Association contacts legislators regularly on issues that affect our growers. Special attention is given to food safety, state budget appropriations, labor, deer crop damage, irrigation (water use), high tunnels, and pesticides as they relate to horticultural growers.

The Association is also a member of the State Council of Farm Organizations, the United Fresh Produce Association and the Penn State Agricultural Council, again with the purpose of representing the vegetable, potato and berry industries in the public arena and to Penn State University researchers and administrators.

The bottom line is this. A \$50 membership in the Pennsylvania Vegetable Growers Association is worth every penny. For each member, about \$60 is given to research and about \$28 is spent to publish the **Pennsylvania Vegetable Grower News**. Normally members can save another \$90 or more per person on three-day registration fees for the Mid-Atlantic Fruit and Vegetable although this year the registration for the virtual Convention is a flat rate for members and non-members. Still PVGA membership is a bargain.

Because both the in-person versions of the Farm Show and Mid-Atlantic Convention will not be happening this year, PVGA will be facing a major drop in its income for the year. Thus membership dues become much more important. If you are a current PVGA member, PLEASE be sure to renew your membership 2021. If you are not currently a PVGA member, PLEASE join the Association for 2021 – to enjoy this newsletter, the American Vegetable Grower magazine and the Vegetable Growers News each month and support the Association that represents your livelihood.

Use the form on page 34 of this newsletter to join today!

*The **Pennsylvania Vegetable Growers News** is the official monthly publication of the*

Pennsylvania Vegetable Growers Association, Inc.,

815 Middle Road, Richfield, PA 17086-9205

Phone and fax: 717-694-3596 • Email: pvga@pvga.org • Website: www.pvga.org

Our Mission:

The Pennsylvania Vegetable Growers Association serves Pennsylvania's commercial vegetable, potato and berry growers through education, research, advocacy and promotion.

Our Vision:

The Pennsylvania Vegetable Growers Association will be the driving force in ensuring the future viability of the commercial vegetable, potato and berry industries in Pennsylvania.

Inquiries about membership, this publication or advertising rates should be directed to William Troxell, Executive Director, at the above address.

GENERAL

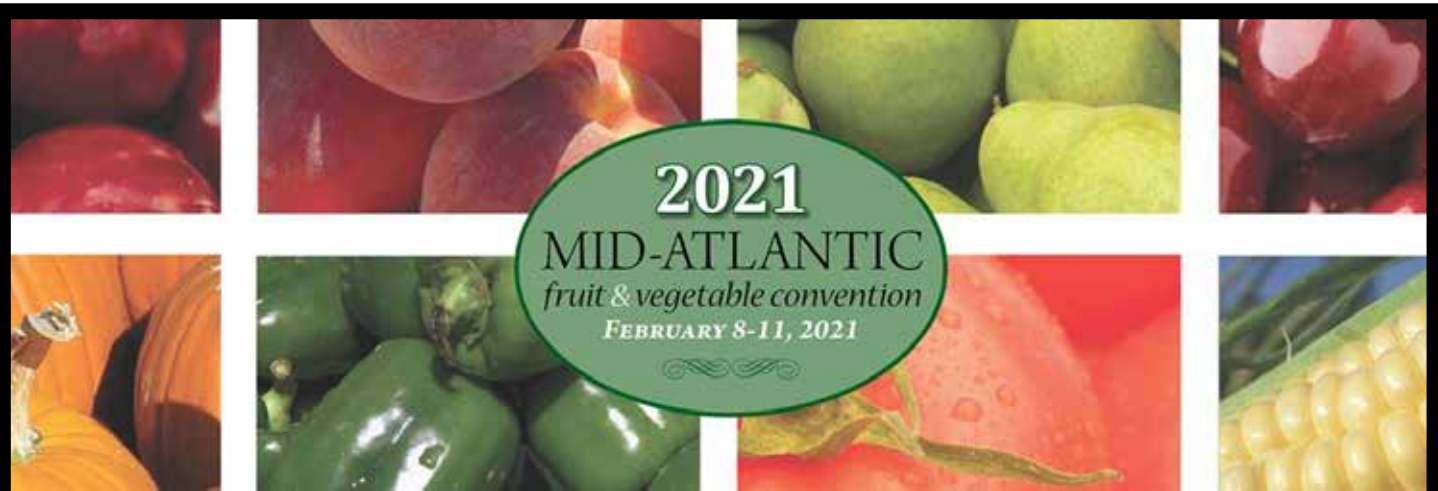

The Educational Sessions and Trade Show of the 2021 Mid-Atlantic Fruit and Vegetable Convention will be available online through March 31, so even if you missed the live event, you can still “attend”.

44 Virtual Educational Sessions

with over 40 pesticide credits available

Vegetable Track:

4 General Vegetables, Hydroponics/Greenhouse Vegetables, Post-Harvest Food Safety, Specialty Vegetables, Sweet Corn, Soil Health/Cover Crops, Organic Vegetable Production, Vegetable Lunch-N-Learn, Vine Crops, Cole Crops, Tomatoes, Vegetable Biocontrols, High Tunnels, 3 Potatoes, Pumpkins/Winter Squash

Small Fruit Track:

Strawberries, Brambles/PYO, 2 Blueberries, Small Fruit Lunch-N-Learn

Marketing Track:

Wholesale Marketing, Creative Marketing, Economies of Online Sales, Agritourism, CSAs, E-Commerce – Platform and Marketing Options, Farm Markets Post-COVID, Digital/Social Marketing

General Track:

Third-Party Liability, Ag Workplace/Legal Compliance COVID-19, Honeybees for Pollination, Spanish

Tree Fruit Track:

Entomology, Plant Health, Horticulture/Physiology, 2 Stone Fruit, Tree Fruit Lunch-N-Learn, Ag Engineering,

Virtual Trade Show

featuring the latest in grower & direct marketing supplies!

For information and to register visit www.mafvc.org or call 717-694-3596
Full-access registration is \$40

VENDORS BY CATEGORY

Vendors are listed below by category of the equipment, supplies or services they offer. An alphabetical listing of vendors and their addresses begins on page 25.

General Equipment

Tillage and Cultivating Equipment

- Hillside Cultivator – 717-626-6194
- I & J Manufacturing – 717-442-9451
- Market Farm Implement – 814-443-1931
- Wes Stauffer Engine and Equipment – 717-738-4215
- Woodhouse, J. S. – 717-938-5100

Planting Equipment

- Black Rock Repair 717-529-6553
- I & J Manufacturing – 717-442-9451
- Market Farm Implement – 814-443-1931
- Martin's Produce Supplies – 888-381-8641
- Marvel, Robert, Plastic Mulch – 800-478-2214
- Mechanical Transplanter Co. – 800-757-5268
- Nolt's Produce Supplies – 717-656-9764, 661-7069
- Pequea Planter – 717-442-4406
- Rain-Flo Irrigation – 717-445-3000
- Stand'N Plant – 724-639-3965
- Woodhouse, J. S. – 717-938-5100

STAND 'N PLANT

SEEDER

Use for...

- Seeds
- Onions
- Garlic



Easily plant hundreds of seeds or plants per hour into plastic covered or bare ground seed beds.

PLANTER

Use for...

- Transplants
- Potatoes
- Bulbs



Stand 'N Plant

95 Rose Road, Saltsburg, PA 15681

Phone: 724-639-3965 or visit: www.standnplant.com

MaterMacc Precision Vacuum Planters

Finally, One Planter For All Seed!

Market Farm Implement, Inc.
814-443-1931
www.MarketFarm.com





WE ALSO STOCK:
Transplanters • Rototillers • Cultivators
Bed Shapers • Sprayers • Mulch Layers
Spading Machines • Wash Lines
Potato Diggers • Veg. Harvesters

MaterMacc

Two row shown with Easy Set Toolbar and Stainless Steel fertilizer and insecticide hoppers.

Plants All Size Seed from Raw Lettuce to Pumpkin!
Quick Change Row Spacings!
Quick Change Seed Variety!
Quick Fertilizer Clean Outs!
1.5 Thimble Seed Charging!
Ideal for Corn & Pumpkin!

Hillside Cultivator Co. LLC



Hydraulic adjusted cultivator
for the edges of plastic mulch



Cultivators especially for
Strawberries



Eco Weeder for close cultivation
around individual plants

For more information visit hillsidecultivator.com

Contact: John Shenk 717-669-3158 Lititz, PA hillsidecultivator@gmail.com

VENDORS BY CATEGORY

RAIN-FLO IRRIGATION

ALL NEW EQUIPMENT MODELS
FOR 2021!!



MODEL 2570

*Serving your irrigation needs...
Call today for your free catalog.*



MODEL 1670

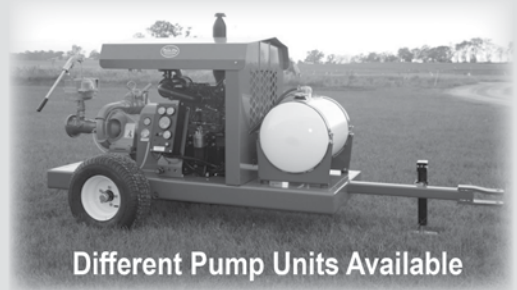

Different Pump Units Available

Mfg. of Vegetable Machinery
Sales of Drip Irrigation & Plastic Mulch
Retail ▪ Wholesale

**929 Reading Rd
East Earl, PA 17519
(717)445-3000
www.rainfloirrigation.com**

VENDORS BY CATEGORY

General Equipment

Bedders, Bed Shapers, Drain Ditchers, Tool Bars and Accessories

Market Farm Implement – 814-443-1931
 Nolt's Produce Supplies – 717-656-9764, 661-7069
 Rain-Flo Irrigation – 717-445-3000

Fertilizer Application Equipment

Market Farm Implement – 814-443-1931
 Mechanical Transplanter – 800-757-5268

Plasticulture Equipment

CropCare – 717-738-7365
 DuBois Agrinovation – 800-667-6279
 Martin's Produce Supplies – 888-381-8641
 Market Farm Implement – 814-443-1931
 Marvel, Robert, Plastic Mulch – 800-478-2214
 Mechanical Transplanter Co. – 800-757-5268
 Nolt's Produce Supplies – 717-656-9764, 661-7069
 Rain-Flo Irrigation – 717-445-3000
 Saylor's Farm Products – 814-745-2306

Harvesting Equipment

Black Rock Repair 717-529-6553
 CropCare – 717-738-7365
 Fisher Sprayer Manufacturing – 717-768-7619
 I & J Manufacturing – 717-442-9451
 Market Farm Implement – 814-443-1931
 Martin's Produce Supplies – 888-381-8641
 Nolt's Produce Supplies – 717-656-9764, 661-7069
 Rain-Flo Irrigation – 717-445-3000



BCS

THE BEST TILLER ON EARTH
 No Belts • No Chains • No Equal



\$100 to \$300 Off Select Models

- 18" To 30" Tilers
- Models 7 To 13HP
- Quick Change Handle Positions
- No Time-Limit Warranty on Transmissions
- 50% Higher Tine Speed Than Competition
- FREE Quick Hitch w/2+ Attachments On 732 To 853

See the Model 770 Hydro!



Rotary Plow



Power Harrow



Brush Mowers



Sickle Bar Mowers



Snow Throwers

Also: Flail Mowers • Chipper/Shredder • Wood Splitter • Utility Trailer

WES STAUFFER EQUIPMENT LLC
www.wesstauffer.com 717-738-4215
BCS Dealer For 34 Years!
 23 Pleasant Valley Rd., East of Ephrata off Rt. 322 • Mon., Wed. & Thurs., 8-5:30; Tues. & Fri., 8-7; Sat., 8-1

**SEE VIDEOS OF SPRAYERS IN ACTION ON UPDATED WEBSITE!
 NEW HYDRAULIC FOLD SPRAYER FEATURES
 AIRBAG BOOM SUSPENSION!**



200, 300 & 400 Gal. Manual Fold • 300 & 400 Gal. Hyd. Fold

Ask us about the advantages of the front mount boom.

PENNS CREEK MFG.

1340 Broadway Rd., Winfield, PA 17889

570-837-1197

www.pennscreekwelding.com

BUILDERS OF DEPENDABLE ECONOMICAL VEGETABLE SPRAYERS

VENDORS BY CATEGORY

Two Locations to Serve You Better!



Nolt's Greenhouse Supplies

Specializing in Greenhouse and Nursery Growing Supplies

(717) 354-8376

151 E. Farmersville Road
Ephrata, PA 17522



Nolt's Produce Supplies, LLC

Specializing in Vegetable Growing Supplies and Equipment

(717) 656-9764

152 N. Hershey Avenue
Leola, PA 17540



Compact Raised Bed Mulch Layer



Greenhouses & High Tunnels



Hyd Reset Mulch Lifter



Hyd Drive Wrapper



Water Wheel Transplanter

Please contact us for our free commercial growers catalogs or view it on our website: www.noltsproucesupplies.net

MECHANICAL TRANSPLANTER COMPANY

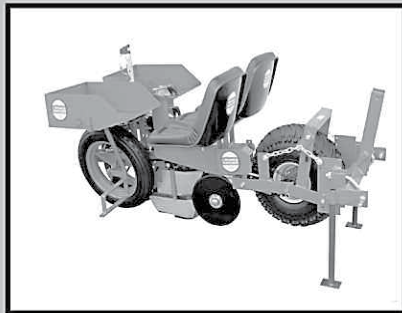

Model 1000

- * Excellent for bare root and small cells. Our most popular transplanter.

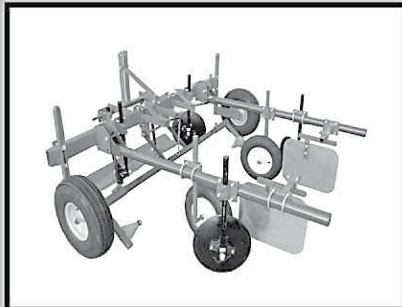

Model 90

- * Lays any size mulch from 3-6 feet wide.

NEW CLEAN SEEDER



MODEL JP-1

- * Excellent for small seed
- * Lightweight & easy to handle
- * Accurate spacing

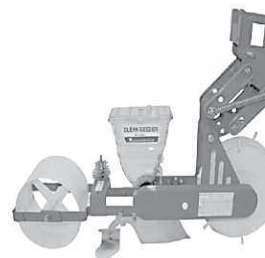

MODEL JPH

- * Row spacing as close as 7"
- * Mounts on 2" square toolbar

Mechanical Transplanter Company, LLC * 1150 Central Avenue * Holland, MI 49423
 Phone: 616-396-8738 or 800-757-5268 * Fax: 616-396-3619
 website: www.mechanicaltransplanter.com * e-mail: mtc@mechanicaltransplanter.com

VENDORS BY CATEGORY

General Equipment

Irrigation Equipment and Supplies

DuBois Agrinovation – 800-667-6279
 Gristmill Farm – 717-354-8443
 Harris Seeds – 585-754-5245
 Keystone Fence Supplies – 717-949-8170
 Market Farm Implement – 814-443-1931
 Martin's Produce Supplies – 888-381-8641
 Marvel, Robert, Plastic Mulch. – 800-478-2214
 Nolt's Produce Supplies – 717-656-9764, 661-7069
 Rain-Flo Irrigation – 717-445-3000

Pesticide Application Equipment

Black Rock Repair 717-529-6553
 CropCare – 717-738-7365
 Fisher Sprayer Manufacturing – 717-768-7619
 Market Farm Implement – 814-443-1931
 Martin's Produce Supplies – 888-381-8641
 Martin's Repair Shop – 717-733-3015
 Penns Creek Welding – 570-837-1197
 Woodhouse, J. S. – 717-938-5100



MRS AIR BLAST SPRAYER

5 X 5 Spray Head
 Sprays 12-15 Ft.
 on both sides

- > 23 HP Vanguard engine
- > Electric start
- > 60 gallon tank
- > Trailer hook up
- > Electric diaphragm pump

PRODUCED BY

Martin's
 Repair Shop LLC

27 W Mohler Church Rd. Ste
 1 Ephrata, PA 17522
 717-733-3015

CROPCARE

Shielded Sprayers



The Plastic Mulch Lifter-Wrapper

(PR2500) combines the lifting and wrapping of plastic mulch into ONE EASY PASS.



The Picking Assistant

(PA1600) is a motorized field hand designed to boost your picking productivity and reduce sore backs!

See these machines in action at:

CropCareEquipment.com

CropCareEquipment.com | Lititz, PA
 Manufactured by PBZ LLC, a Paul B. Zimmerman, Inc. company

Please contact your local CropCare® dealer with any questions.

Cedar Grove Farm Store
 Shippensburg, PA.... 717-532-7571

Rovendale Ag & Barn
 Watertown, PA..... 570-538-9564

VENDORS BY CATEGORY

BiO 360[®]

Biodegradable | Compostable Mulch Film



Made from Mater-Bi



No negative impact on soil



Suitable for many types of crops



Several thicknesses available

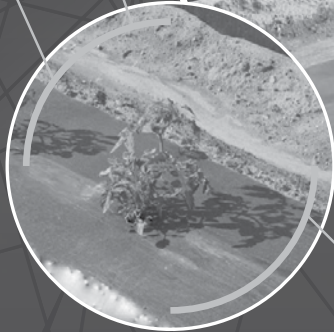

Sustainably produced

Certifications



Nolt's Produce Supplies

717-656-9764 - Leola, PA

noltsproucesupplies.net

For other regions, contact us

1-844-4BiO360 (1-844-424-6360)



VENDORS BY CATEGORY

General Equipment

Grading, and Packing Equipment

Black Rock Repair – 717-529-6553
 Market Farm Implement – 814-443-1931
 Martin's Produce Supplies – 888-381-
 Nolt's Produce Supplies – 717-656-9764, 661-7069
 Rain-Flo Irrigation – 717-445-3000
 Tew Manufacturing Corp. – 800-380-5839

Wholesale Labeling Equipment

Texpak – 800-645-3416

Refrigeration and Storage Systems

Arctic Refrigeration – 585-343-2678
 KoolJet Refrigeration – 866-748-7786

TEW MANUFACTURING CORP.

**Fruit & Vegetable Cleaning &
Sizing Equipment & Parts**

**Quality Latex & Poly Sponge
Rubber Drying Donuts**

Tuff Foam® Protective Padding

Brushes • Bearings • Sizing Chains

Belting • Scrubber Rubber

New Stainless Steel Machines

**CALL TOLL FREE 800-380-5839
FOR CATALOG & PRICES**

TEW MFG. CORP.

P.O. BOX 87

PENFIELD, NY 14526

585-586-6120

FAX: 585-586-6083

www.tewmfg.com

**Improve the planting, maintenance
and harvesting of your produce!**



Proveyor Wagon - Hydraulic conveyor harvester



25 Old Leacock Rd
 Ronks PA 17572
 717-768-7619

ProveyorWagon.com

*Innovative equipment
for produce farmers.*

Manufactured in
 Lancaster County by:



Fresh Market Snap Bean Harvester



*3 Point Hitch
with Adjustable
Hydraulic Offset*

SOLD BY:

Market Farm Implement, Inc.

257 Fawn Hollow Road • Friedens PA 15541

814-443-1931

www.MarketFarm.com

• VISITORS BY APPOINTMENT •

VENDORS BY CATEGORY



MARRONE BIO INNOVATIONS
**BIO-BASED SOLUTIONS FOR PLANT
 HEALTH AND CROP PROTECTION**



Stargus® Biofungicide Controls Diseases
 Provides broad spectrum disease control on challenging diseases such as downy mildew and *Botrytis*.

Common Crops: Leafy Greens, Grapes, Cucurbits, Apples, Strawberries, Blueberries, Fruiting Veggies, Cole Crops



Grandevo® WDG Bioinsecticide for Pest Management
 Repel, stop feeding, reduce reproduction and induce mortality to prevent damaging insects, flies and mites.

Common Crops: Blueberry, Citrus, Cucurbits, Fruiting Vegetables, Grapes, Leafy greens, Medicinal Plants, Pome fruit, Potatoes, Strawberry, Tree Nuts



Regalia® Biofungicide Controls Bacterial Diseases
 Increases crop performance by stimulating a plant's ability to fight diseases such as powdery mildew.

Common Crops: Almonds, Blueberries, Citrus, Cucurbits, Fruiting Vegetables, Grapes, Leafy Greens, Pome Fruit, Potatoes, Stone Fruit, Strawberries, Tobacco, Tree Nuts



Jet-Ag® is a Multipurpose Sanitizer
 Broad Spectrum Peroxyacetic Acid (PAA) Sanitizer with two-times the oxidative power to control algae, fungi and bacterial diseases in agricultural and horticultural use. Use as a foliar spray, on greenhouse surfaces and equipment, seed bed treatments, post seed germination, post-harvest storage fogging.



Venerate® XC Bioinsecticide Improves Insect Control
 Effective against a wide variety of chewing and sucking insects and mites and helps reduce chemical residue.

Common Crops: Blueberry, Citrus, Cucurbits, Fruiting Vegetables, Grapes, Leafy greens, Medicinal Plants, Pome fruit, Potatoes, Strawberry, Tree NutsVegetables, Grapes, Leafy greens, Medicinal Plants, Pome fruit, Potatoes, Strawberry, Tree Nuts

JOIN US!
 Vegetable & Small Fruit
 Pest Management
 Weekly Teleconference



Majestene® Bionematicide for Nematode Control
 Effective nematode control management tool active against eggs, juveniles and adult lesion, root knot, dagger, stunt, reniform and soybean cyst nematodes.

Common Crops: Blueberry, Cucurbits, Fruiting Vegetables, Leafy Greens, Potatoes, Strawberry, Tobacco



Learn about current vegetable and small fruit pest management pressures and how to deliver safe, effective solutions!

Wednesdays: 12:30-1pm
 4/21/21 thru 9/8/21
 515-604-9914
 Use code: 832191
 Recordings: 515-604-9875
Questions:
 sbogash@marronebio.com
 or 717-877-7105



CAN BE USED IN ORGANIC PRODUCTION



Steve Bogash, Territory Business Manager, NE and Mid-Atlantic
 717-877-7105 • sbogash@marronebio.com • Marrone BioInnovations

VENDORS BY CATEGORY

General Supplies

Mulching/Row Covers

- DuBois Agrinovation – 800-667-6279
- Gristmill Farm – 717-354-8443
- Harris Seeds – 585-754-5245
- Martin’s Produce Supplies – 888-381-8641
- Marvel, Robert, Plastic Mulch – 800-478-2214
- Mechanical Transplanter Co. – 800-757-5268
- Nolt’s Produce Supplies – 717-656-9764, 661-7069
- Rain-Flo Irrigation – 717-445-3000

Fertilizer

- Fertrell Company – 717-367-1566
- Grower Mineral Solutions – 800-437-4769
- Martin’s Produce Supplies – 888-381-8641
- Nolt’s Produce Supplies – 717-656-9764, 661-7069
- PA Service & Supply – 717-334-6129

Pesticides/Plant Growth Regulators

- Certis USA – 800-250-5024
- Corteva – 814-207-1428
- Fertrell Company – 717-367-1566
- FMC – 717-304-8957
- Martin’s Produce Supplies – 888-381-8641

Farm Equipment Supplies

- PA Service & Supply – 717-870-3467, 357-3455

Improve the planting, maintenance and harvesting of your produce!



RoHand II - Work smarter, not harder.



HarvestProMFG.com

Innovative equipment for produce farmers.

25 Old Leacock Rd
Ronks PA 17572
717-768-7619

Manufactured in Lancaster County by:



See us for your weed control needs

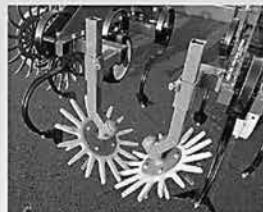

Finger Weeder



Rotary Hoe with Shield



Rotary Hoe with Walking Beam

- We also carry:**
- Cover Crop Rollers
 - Non-plugging
 - Sickle Bar Mowers



(717) 442-9451
10 South New Holland Road, Suite 2
Gordonville, PA 17529

VENDORS BY CATEGORY



OUTSTANDING

SEED COMPANY, LLC[®]

B R E E D E R | P R O D U C E R

Outstanding Seed is an innovative seed company specializing in breeding, production, and marketing of proprietary, large handled, high yield potential, Powdery mildew resistant pumpkin, gourd, and winter squash hybrids.

Outstanding Seed hybrids are bred for large handles, high yield potential, and Powdery mildew resistance. For this reason, Outstanding Seed hybrids are market leaders in yield potential and profit potential.

Over forty hybrids are available to meet many different needs. Call today to place an order or request our 2021 Catalog.

Warty Sunset^{F1}

- Large, warty, rough textured, deep red fruit, many with varying levels of charcoal striping, and some with salmon striping.
- Average fruit weight is 23 lbs., some to 30 lbs.
- Colorful, most unique new hybrid stands out at retail markets. Fantastic for mixed bins also.
- Strong Powdery mildew resistance.
- Excellent yield potential.
- FarMore[®] treated seed and untreated seed are both available.



**NEW
FOR
2021**

VENDORS BY CATEGORY

Refrigerated and Ventilated Cooling Systems for Fruit and Vegetable Storages

- COMMERCIAL REFRIGERATION
- DESIGN, SALES AND SERVICE
- SERVING AGRICULTURE FOR OVER 70 YEARS

Free Consultation and Quote
Call Mike Mager at 585-343-2678



ARCTIC
REFRIGERATION CO. OF BATAVIA
26 Cedar Street, Batavia, NY 14020
www.arcticrefrigeration.com

Since 2001 Authority in Refrigeration for
Agro-Industrial Applications in North America.

PLUG
AND
PLAY



FREE
COOLING

- Thru the Wall
- Portable
- Roof Mounted
- Hydrocoolers
- Custom Designs
- Blast Freezers
- Chillers
- Greenhouse
Coolers





1.866.748.7786
info@kooljet.com





**PRODUCER OF NATURAL
AND ORGANIC
FERTILIZERS AND SOIL
AMENDMENTS SINCE 1946**

**CONTACT US FOR A COPY OF OUR NEW CATALOG! CALL OUR OFFICE: 800-347-1566
EMAIL US AT [INFO@FERTRELL.COM](mailto:info@fertrell.com) OR VISIT US ONLINE AT WWW.FERTRELL.COM**

VENDORS BY CATEGORY



KRATOS

Kratos is a strong 20-30 lb standout in the patch. Its large firmly attached handle is perfect for picking while its high yield potential is great for increased profits.



ORANGE SUNRISE

Orange Sunrise is an early maturing precocious variety with a uniform round shape, and a nice deep color. It produces orange fruit very quickly for a patch standout.



RED MORNING

Red Morning's strong plant brings large uniform fruit for high consumer appeal and early maturing fruit so growers can be first to market.



WAYFARER

Wayfarer is a Sugar Baby triploid with a strong plant, traditional sugar baby flavor, and firm crisp flesh with outstanding tolerance to hollow heart.



MECATE

Mecate offers high yields of smooth, uniform, thick-walled fruit with a concentrated set for increased profits. Its yellow color is long lasting without turning orange.



TRIBUTE

Tribute is a dark green zucchini with a medium upright plant and open vine that produces high yields of straight cylindrical fruit. A great choice with a strong disease package.

For more information, call:

Nolt's Produce Supplies, LLC • (717) 656-9764
152 North Hershey Avenue, Leola, PA 17540-9711

COMMUNICATIONS DIVISION | LUST79301120

VENDORS BY CATEGORY

General Supplies

Biocontrols – Beneficial Insects

Certis USA – 800-250-5024
IPM Laboratories – 315-497-2063

Cover Crop Seeds

King's Agriseeds – 717-687-6224

Wildlife/Bird Damage Control Products

DuBois Agrinovation – 800-667-6279
Marvel, Robert, Plastic Mulch – 800-478-2214

Containers and Packaging Supplies

DuBois Agrinovation – 800-667-6279
Harris Seeds – 585-754-5245
Martin's Produce Supplies – 888-381-8641
Nolt's Produce Supplies – 717-656-9764, 661-7069
ProducePackaging.com – 800-644-8729
Putnam Plastics – 800-457-3099
Saylor's Farm Products – 814-745-2306
Statewide Bag Service – 717-647-2623

Trellising/Fencing Supplies/Equipment

Keystone Fencing Supplies – 717-949-8170



Saylor's Farm Products

*We Also Make Watercaps
For Earlier Tomatoes*

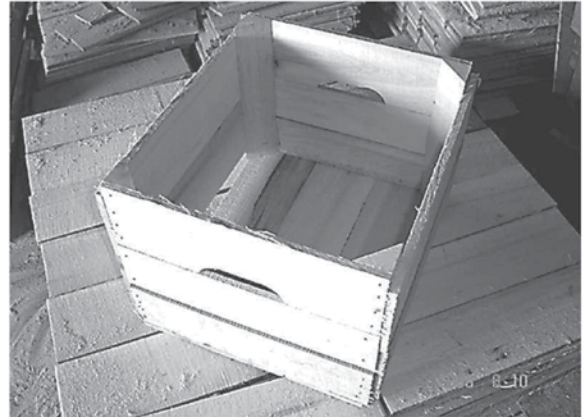

Manufacturers of Agricultural Containers.
www.saylorsfarm.com



Saylor's Farm Products

17319 Route 68, Sligo, PA 16255
Phone 814-745-2306
john@saylorsfarm.com

ProducePackaging.com[®]
for all your produce packaging needs

1-800-644-8729

Kurt Zuhlke & Assoc., Inc.
P.O. Box 609, Bangor, PA 18013



Over 45 Years In The Industry

For over 45 years, Kurt Zuhlke & Assoc., Inc. has been a part of the many innovative packaging concepts utilized by the produce industry.



High Quality Products And Services

Our packaging is designed to protect produce, provide excellent visibility to the consumer, reduce shrinkage and enhance the product. We also offer professional labeling design and application.



From Farmers To Repackers

Whether you are ordering a case or a truck load, you can rest assured that we have the ability and capacity to service your orders quickly.



VENDORS BY CATEGORY



YOUR ACRES.
YOUR LIVELIHOOD.
OUR PRIORITY.



CRACKERJACK



80-82 Triploid Seedless Watermelon

Consistent yields over wide range of growing conditions. Very uniform fruit shape, firm flesh and deep red interior. If you are catering towards bins or cartons, this variety should definitely be on your farm. 13-17 lbs.

SWEET BABY JANE



105-110 Day Medium/Large Pumpkin

One of our favorites for size and reliability, Sweet Baby Jane has shown adaptability to set in warmer conditions. Fruit is distinctive with a long and sturdy handle and a blocky round to round-flat shape. Recommended spacing is no less than 18 square feet apart. 15-30 lbs. IR: Sf

COASTAL



76 Day Bicolor SH2 Sweet Corn

High quality shipper ear with a short shank and sturdy plant. Great tipfill. Dark green husks with attractive flags. HR: Ps (Rp1G)

Visit Us Online At WWW.SEEDWAY.COM or Call (800) 952-7333

VENDORS BY CATEGORY

Vegetable Supplies

Vegetable Plants

Harris Seeds – 585-754-5245
Keystone Fence Supplies – 717-949-8170
Re-Divined – 717-875-6644

Vegetable Seeds

Harris Seeds – 585-754-5245
Martin's Produce Supplies – 888-381-8641
Nolt's Produce Supplies – 717-656-9764
Outstanding Seed Co. – 877-248-4567
Rupp Seeds – 419-337-1841
SeedWay – 800-952-7333
Stokes Seeds – 800-263-7233

After 12 years of grafting...

Let our mistakes along the way pay
for your success! We supply
custom orders of GRAFTED plants
including: Tomato, Pepper,
Eggplant and Watermelon.



142 Black Swamp Rd.

Bainbridge, PA 17502

717-286-7658 ★ grafted@redivined.net



Paper & Poly Potato Bags
Mesh Bags for Onions, Cabbage & Sweet Corn
Fischbein Sales & Service
Thread & Wire Ties



Large inventory of Produce Packaging
2lb. to 50 lb. Paper Potato Bags
Paper Master Containers
Poly Potato Bags
3 lb. 10 lb. 25lb. & 50 lb. Mesh Onion Bags
Mesh Cabbage & Mesh Sweet Corn Bags
Wire Ties & Kwik Loks
Fischbein Portable Bag Closers
Fischbein Parts & Repairs done on site
Thread / 8 oz. to 20 lb. Cones

CALL

717-647-2623 -717-460-7962

Visit our website at

www.tallmanpotatoes.com

see our full line of products

CALL STATEWIDE BAG SERVICE

FOR YOUR

PRODUCE PACKAGING NEEDS

HIGH QUALITY PRODUCTS

& PERSONALIZED SERVICE

sjtallman@tallmanpotatoes.com

VENDORS BY CATEGORY

Keep Your Cash Longer

Industry-Leading, In-House Credit Terms Built on Trust

Just as you trust us with your business, we trust you with ours. With the Harris Seeds credit program, **you don't have to worry about paying us until November 1**, when your season is behind you and your cash is in the bank. And just as we help you keep your hard-earned cash for longer, we're also bringing you the most profitable vegetable varieties to help you earn even more of it.

When you shop with Harris Seeds, you'll enjoy...

- ★ **Generous, multi-tiered discounts**
- ★ **Grower-friendly credit terms**
- ★ **Industry-leading varieties that support your profitability**



Great for Farmer's Markets

"I grow Red Deuce in tunnels to get an earlier start on my season. They do really well and sell great at our farmer's market."
— Joe H.

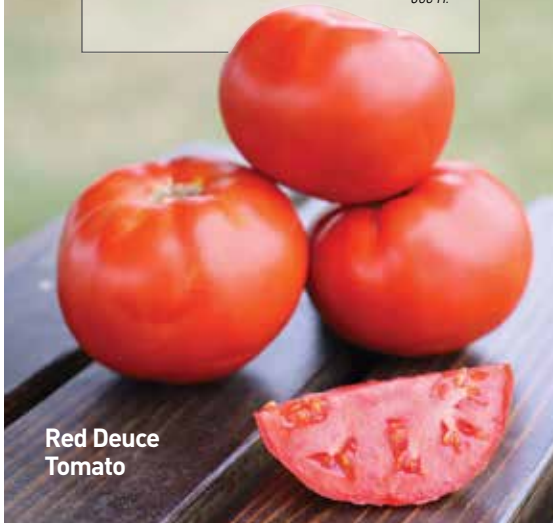

Red Deuce Tomato



"They should rename Kratos 'The Money Maker.'

Second year growing Kratos and I'm going to double down on them for next season. Sold every single one I picked. Best consistency of size and shape, best handles that don't break, best vine health, and best money maker I've had."

— Patrick R.

Kratos Pumpkin



Revolution Pepper



Best Pepper Ever

"The Revolution pepper is the best I've ever grown and eaten. They are large, thick walled, juicy and sweet. I started mine indoors in March and had peppers by July through to frost. They are great for stuffing as well Love them!"

— Nancy A.

Call us at 800.544.7938 to take advantage of our credit terms or use the code 1PVGJAN to get 5% off your order* at harriseseeds.com.

* Discount code valid through March 31, 2021.



VENDORS BY CATEGORY

Small Fruit Supplies

Berry Nurseries

Keystone Fence Supplies – 717-949-8170
 Maplewood Produce Greenhouse – 717-532-3278
 Nourse Farms, Inc. – 413-665-2658

Greenhouse Supplies & Equipment

Greenhouse Equipment and Supplies

DuBois Agrinovation – 800-667-6279
 Fertrell Company – 717-367-1566
 Gristmill Farms – 717-354-8443
 Harris Seeds – 585-754-5245
 IPM Laboratories – 315-497-2063
 Keystone Fence Supplies – 717-949-8170
 Lambert Peat Moss – 888-632-8808
 Martin's Produce Supplies – 888-381-8641
 Martin's Repair Shop – 717-733-3015
 Marvel, Robert, Plastic Mulch – 800-478-2214
 Nolt's Greenhouse Supplies – 717-354-8376
 Rimol Greenhouse Systems – 603-494-5775





NOURSE
The Best Berry Plants Since 1932

**The Leading
Small Fruit Nursery Today!**

- *Excellent Customer Service*
- *Wide Variety Selection*
- *Technical Support*
- *Complete Lab Facility for
Tissue Culture & Virus Indexing*

Strawberry
Raspberry
Blackberry
Blueberry
Currant
Gooseberry
Elderberry
Asparagus
Rhubarb



Nourse Farms
 41 River Road
 South Deerfield MA 01373
 413.665.2658

noursefarms.com
 info@noursefarms.com

STRAWBERRY PLANTS

Plugs for
 August & September Planting
 Varieties Available:

Sweet Charlie Galletta Chandler
Flavorfest Camarosa Camino Real
Keepsake Ruby Jane Malwina Sensation
 Day Neutral:

Albion San Andrea Monterey

Tips are harvested from
 tissue-cultured plant stock.

Pick Up - Delivered
Can Ship Motor Freight or FedEx

Maplewood Farm Market, LLC

Reuben R. Martin
717-532-3278

VENDORS BY CATEGORY

RAISING THE BAR

While its “dirty brown” exterior may not be what consumers are used to seeing, its true beauty is on the inside. **Ugly Dumpling** is one of the best tasting winter squash varieties you will ever eat. This new **Rupp** exclusive is also a great option for fall decoration.

UGLY DUMPLING



XANADU

Xanadu is part of the Nirvana series from **Crookham** and incorporates a stronger plant, higher ear placement and improved disease resistance while maintaining exceptional eating quality and consumer appeal.



CADENCE XR

Cadence XR is a full season, (78 day), high eating quality sweet corn hybrid with ideal ear size for roadside markets. This **IFSI** variety has an attractive husk package with good flag leaves which will make a nice presentation at your stand.



TARPON

Tarpon is a main-season bell pepper hybrid, from **Seminis**, with X10R® technology and intermediate resistance to phytophthora blight. It has a compact plant and produces dark green, smooth blocky fruit.

RAISING THE BAR IN QUALITY, FLAVOR, AND YIELD

Bringing you the best products in partnership with
Crookham, IFSI, and Seminis.

Visit ruppseeds.com to request or download your copy
of our 2021 catalog including 40 new products.



SEE WHAT GOOD YIELDS®

800-700-1199 • ruppseeds.com

VENDORS BY CATEGORY

Greenhouse Supplies & Equipment

Bedding Plant Seeds/Plugs/Cuttings

Harris Moran Seeds – 209-579-7333
 Harris Seeds – 585-754-5245
 Stokes Seeds – 800-263-7233

Greenhouse and Low/High Tunnel Structures

Nolt's Greenhouse Supplies – 717-354-8376
 Rimol Greenhouse Systems – 603-494-5775

Growing Media

Gristmill Farms – 717-354-8444
 Lambert Peat Moss – 888-632-8808
 Martin's Produce Supplies – 888-381-8641
 Nolt's Greenhouse Supplies – 717-354-8376

lambert

PREMIUM PROFESSIONAL PEAT-BASED SUBSTRATES



FOR ALL YOUR GERMINATION AND ALL PURPOSE NEEDS



JEFFREY P. BISHOP

Cell: (315) 480-1900

Toll Free: (888) 632-8808

lambertpeatmoss@aol.com

www.lambertpeatmoss.com

Your Source for . . .

HIGH TUNNELS



Call Harry Edwards @ 717.606.8021
 or Email hedwards@rimol.com



MartinsProduceSupplies.com

717-532-5918

888-381-8641

- Greenhouses
- Pots & Containers
- Soil
- Fertilizers
- Pesticides
- Irrigation
- Sprayers
- Produce Washing Lines
- Produce Equipment
- Much more

VENDORS BY CATEGORY

You can't control the weather.
But you CAN manage your risk.

Protect your assets with
crop insurance.

Enroll by March 15

Contact your local FSA office or find a crop insurance agent under "Risk Management" at
AGRICULTURE.PA.GOV/AGBIZ or call 717-409-0219



Paid for with Pennsylvania taxpayer dollars.

VENDORS BY CATEGORY

Direct Marketing Supplies

Prepared Foods

Gardner's Pies – 717-629-4225

Farm Market Packaging

Harris Seeds – 585-754-5245
PA Veg. Mktg. & Research Prog. – 717-694-3596
Putnam Plastics – 800-457-3099
Statewide Bag Service – 717-647-2623

Advertising and Promotional Materials –

PA Veg. Mktg. & Research Prog. – 717-694-3596

Services

Associations

Pennsylvania Association for Sustainable Agriculture – 814-349-9856
Pennsylvania Vegetable Growers Association – 717- 694-3596

Auctioneers

Pirrung Auctioneers – 585-728-2520

Crop Insurance

Morrissey, Bernard, Insurance – 800-422-8335

Educational Materials

Carl Cantaluppi – 570-743-7252



WHAT'S IN YOUR PIE?

GARDNER PIE CO.
— Refreshingly —
OLD-FASHIONED

Quality, Variety & Innovation
Since 1945

gardnerpie.com
330.245.2030

Ask us about
our Pre-Baked
Options!

VENDORS BY CATEGORY



We know your time is valuable. That's why our team will meet you in the greenhouse, in the tractor, or at your kitchen table.

Give us a call at **833.277.7443**, say the place, and we'll be there.



Morrissey Insurance is proud to represent an industry as hardworking and dedicated as our farmers!

We are pleased that our customers choose to work with us!
Customer satisfaction is our number one goal.

Here's what one of our valued customers has to say when asked:

"Why do you choose to work with Morrissey Insurance?"

"Morrissey is a family owned and operated business that understands the needs of our family farm and retail business. Their staff is very knowledgeable and helpful and can provide us with the various types of insurance our farm and retail business needs to keep us "safe" doing business in the Lehigh Valley. We have been with Morrissey for many years and are very happy with the service they provide."

Newhard Farms



890 N. Reading Rd., Ephrata, PA 17522
13025 Route 6, Troy, PA 16947
www.insuringyourfuture.com
800-422-8335

VENDORS BY CATEGORY

Services

Financial Services

AgChoice Farm Credit – 800-998-5557
MidAtlantic Farm Credit – 888-339-3334

General Insurance (Liability, Workers Compensation, Health, Fire, etc.)

Agri-Services Agency – 800-256-4105
Morrissey, Bernard, Insurance – 800-422-8335

Government

Pennsylvania Department of Agriculture – 717-705-9511

Management Services/Products

Martin's Produce Supplies – 888-381-8641

Marketing/Management Consultants

Kitchen Table Consultants – 267-275-1198

Produce Auctions

Buffalo Valley Produce Auction – 570-966-1151
Countryside Produce Auction – 814-662-2222
Cumberland Valley Produce Auction – 717-530-5007
Kutztown Produce Auction – 610-683-7161
Lebanon Produce Auction – 717-367-8379
Leola Produce Auction – 717-656-9592
Morrison's Cove Produce Auction – 814-793-9384
New Wilmington Produce Auction – 724-946-8540
Oxford Produce Auction – 610-392-2722
Shippensburg Produce Auction – 717-532-5511
Smicksburg Produce Auction –
Snyder County Produce Auction – 570-374-0284
Sugar Valley Produce Auction – 570-725-2000
Sunnyburn Produce Auction – 717-862-3010
Weaverland Produce Auction – 717-355-0834



VEGETABLE FARM EQUIPMENT
AUCTION SPECIALISTS
PIRRUNG AUCTIONEERS, INC.
JAMES P. PIRRUNG
www.pirrunginc.com
585-728-2520

*"Serving the Buying - Selling Needs of Farmers
Across America Since 1948"*

Asparagus Production---From A to Z

Carl J. Cantaluppi, Jr.
Emeritus Extension Horticulturist
North Carolina Cooperative Extension Service



A comprehensive 68-page regional bulletin that covers the planting, growing, harvesting, and marketing of asparagus, including a budget with costs and expected income per acre, for the serious commercial asparagus grower. This new revision includes 25 color photos of insects, diseases, and planting techniques, along with new PA variety trial results. Written by an asparagus expert with over 30 years of applied research experience in the northeast, southeast and Midwest, enabling asparagus growers to become successful. To order your copy, send a check or money order for \$25.00 to:

Carl Cantaluppi
1222 Grangers Rd., Selinsgrove, PA 17870

VENDORS BY NAME

Vendors by Name

AgChoice Farm Credit *see ad on page 25*

900 Bent Creek Blvd., Mechanicsburg, PA 17050
888-998-5557
www.agchoicefarmcredit.com

Agri-Services Agency

1008 Applejack Dr., Gibsonia, PA 15044
800-256-4105, fax - 724-449-6336
www.AgServAgency.com

Arctic Refrigeration Co. *see ad on page 14*

26 Cedar St., Batavia, NY 14020
585-343-2678
www.arcticrefrigeration.com

Black Rock Repair

858 Pumping Station Rd., Kirkwood, PA 17536
717-529-6553

Buffalo Valley Produce Auction

Violet Road, Mifflinburg, PA 17844
570-966-1151 fax 570-966-2601
www.buffalovalleyproduce.com/

Carl Cantaluppi *see ad on page 26*

1222 Grangers Rd, Selinsgrove, PA 17870
570-743-7252
carl1954@ptd.net

CertisUSA

9145 Guilford Rd., Ste 175, Columbia, MD 21046
800-250-5024
www.CertisUSA.com

Countryside Produce Auction

1695 Savage Rd., Salisbury, PA 15558
814-662-2222

Corteva Agriscience

Jennifer Clark
814-207-1428
www.corteva.us

CropCare *see ad on page 8*

295 Wood Corner Rd., Lititz, PA 17543
717-738-7365 fax - 717-738-7375
www.cropcareequipment.com

Cumberland Valley Produce Auction

101 Springfield Rd., Shippensburg, PA 17257
717-530-5007
cvproduceauction.com

Dubois Agrinovation, Inc. *see ad on page 9*

478 Notre Dame, St-Remi, Quebec, Canada J0L2L0
800-667-6279
www.duboisag.com

Fertrell Company *see ad on page 14*

PO Box 265 Bainbridge PA 17502-0265
717-367-1566
www.fertrell.com

Fisher Sprayer Manufacturing *see ads on page 10 and 12*

25 Old Leacock Rd., Ronks, PA 17572
717-768-7619
www.proveyorwagon.com

DIVERSIFIED VEGETABLE APPRENTICESHIP

Diversified Vegetable Apprenticeship pairs beginning farmers with established growers to provide a guided pathway toward managing or starting a vegetable farm.

Apprentices receive 2,700+ hours of **paid, on-the-job training** & 200+ hours of related coursework over 18 months.

Host farms train the next generation of sustainable farmers & **gain access to a pool of pre-qualified employees** invested in farming as a career.

Apply now at

pasafarming.org/dva

Applications for host farms & apprentices are reviewed on a rolling basis, however we recommend applying by **February 12, 2021**.

Pasa
SUSTAINABLE
AGRICULTURE

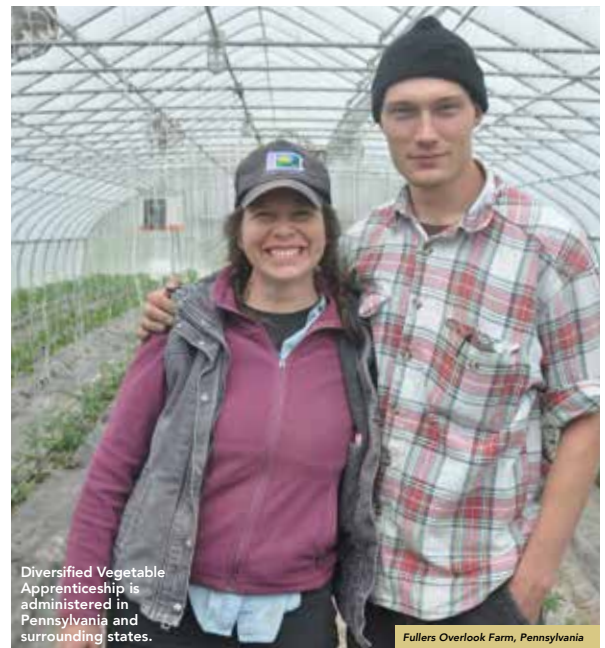

Diversified Vegetable Apprenticeship is administered in Pennsylvania and surrounding states.

Fullers Overlook Farm, Pennsylvania

VENDORS BY NAME



Now Available in Pennsylvania

FieldWatch® is a **voluntary** online program designed to help pesticide applicators view potentially sensitive crops and beehives in their area so they can make informed decisions when preparing to make an application. Developed by Purdue University and other agricultural stakeholders in 2009, this program is now used in 22 states and one Canadian province. In Pennsylvania, the program is being offered as a collaboration between Penn State Extension and the Pennsylvania Department of Agriculture.

Commercial specialty crop growers, commercial and hobbyist beekeepers, and applicators can go to the FieldWatch® website, which contains several mapping tools: DriftWatch® for specialty crop growers, BeeCheck® for beekeepers, and FieldCheck® for applicators. Users can register for the appropriate tool(s). Growers and beekeepers can then mark the locations of their fields and/or hives on a highly accurate mapping tool. This will allow applicators to view specialty crops and beehives near their application sites.

This program receives funding through industry sponsors and is free to use, though users do have the option of becoming supporting members by paying an annual membership fee.

Go to fieldwatch.com for more information and to register.

Please note that the FieldWatch® program is completely voluntary and does not provide a basis for any regulatory or legal action. Growers, beekeepers, and applicators are not required to use FieldWatch® and applicators are permitted to apply whichever pesticides they choose as long as they are following the label and complying with all state and federal laws.

FMC

Michael Myers, Retail Market Manager
717-304-8957
michael.myers@fmc.com www.FMCcrop.com

Frecon Orchard Supply

501 South Reading Ave., Boyertown, PA 19512
610-367-2933

Gardner Pie Co *see ad on page 24*

3077 N Colebrook Road, Manheim, PA 17545
717-629-4225
Kevin.Hickernell@gargnerpie.com

Gowan Co

Alex Deckey, Sales Rep
845-745-9246
adeckey@gowanco.com
www.gowanco.com

Gristmill Vegetable Farm

201 Gristmill Rd, New Holland PA 17557
717-354-8444 fax – 717-354-8444

Growers Mineral Solutions

PO Box 1750, Milan, OH 44846
800-437-4769
www.growersmineral.com

Harris Seeds *see ad on page 19*

355 Paul Road, Rochester, NY 14624
800-544-7938 fax – 877-892-9197
www.harriseseeds.com

Harris Moran Seed Co. *see ad on page 15*

555 Codoni Avenue, Modesto, CA 95357
209-579-7333 fax – 209-544-0335
www.harrismoran.com

Hillside Cultivator *see ad on page 4*

911 Disston View Dr., Lititz, PA 17543
717-626-6194
www.hillsidecultivator.com

I & J Manufacturing *see ad on page 12*

5302 Amish Rd., Gap, PA 17527
717-442-9451
www.farmingwithhorses.com

IPM Laboratories

PO Box 300, Locke, NY 13092-0300
315-497-2063, fax - 315-497-3129
www.ipmlabs.com

Keystone Fence Supplies, LLC

PO Box 268, 280 N. Locust St., Schaefferstown, PA 17088
717-949-8170
www.keystonefencesupplies.com

King's Agri-Seeds

1828 Freedom Rd, Lancaster, PA 17601
717-687-6224
www.kingsagriseeds.com

Kitchen Table Consultants

112 Righters Ferry Rd., Bala Cynwyd, PA 19004
267-275-1198
www.kitchentableconsultants.com

VENDORS BY NAME

Need to earn pesticide applicator recertification credits by mail?

We have the training you need.

New! Penn State Extension now offers pesticide credits by mail! Courses available for both Core and Category needs.

Training available:

- + Pumpkin Diseases
Earn 2 credits Private Category, and Categories 03 and 18.
- + Tomato Diseases
Earn 2 credits Private Category, and Categories 03 and 18.
- + Forage Diseases
Earn 2 credits Private Category, and Categories 01 and 18.
- + Pesticide Spill Protocol
Earn 2 Core credits.
- + Adjuvants and Pesticides
Earn 2 Core credits.
- + Pollinators and Pesticides
Earn 1 Core credit.
- + Pesticide Recordkeeping
Earn 2 Core credits.

Coming in February 2021:

- + Grain and Rodent Burrow Fumigation
Earn 2 Category credits.
- + Soybean Diseases
Earn 2 Category credits.

Learn more and order today!

Call 1-877-345-0691 and speak to our customer service team or order directly from extension.psu.edu/pest-ed-workbooks-2021.

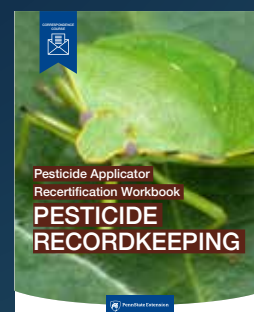
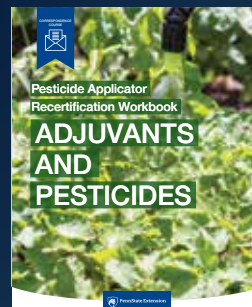
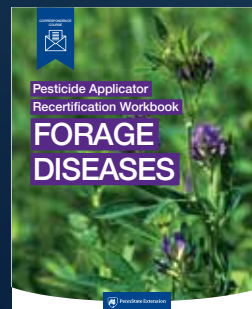
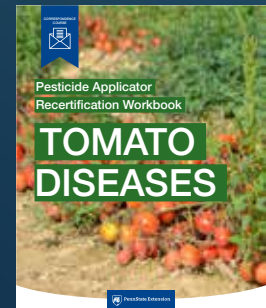

Penn State Extension offers practical, usable, science-based learning you can trust. We are a team of educators and scientists dedicated to improving your health, your home, your business, and your community. Extension is available when and where you need us—online, in the classroom, and at your location. With offices in all 67 counties in Pennsylvania, we can customize our services to your local needs.

Penn State College of Agricultural Sciences research and extension programs are funded in part by Pennsylvania counties, the Commonwealth of Pennsylvania, and the U.S. Department of Agriculture.

This publication is available in alternative media on request.

The Pennsylvania State University encourages qualified persons with disabilities to participate in its programs and activities. If you anticipate needing any type of accommodation or have questions about the physical access provided, please contact Penn State Extension at 877-345-0691 in advance of your participation or visit.

Penn State is an equal opportunity, affirmative action employer, and is committed to providing employment opportunities to all qualified applicants without regard to race, color, religion, age, sex, sexual orientation, gender identity, national origin, disability or protected veteran status.

VENDORS BY NAME

KoolJet Refrigeration *see ad on page 14*

1444 Bell Mill Side Rd., Tillsonburg, ON Canada N4G 4G9
866-748-7786 fax – 519-688-5962
www.kooljet.com

Kutztown Produce Auction

209 Oakhaven Rd., Fleetwood, PA 19522
610-683-7161 fax 610-683-5429
www.kutztownproduceauction.com

Lambert Peat Moss *see ad on page 22*

106 Lambert Rd., Riviere-Ouelle, QU Canada G0L 2C0
888-632-8808, 315-480-1900
www.lambertpeatmoss.com

LancoGAP Services, LLC

183 S. Farmersville Rd., Leola, PA 17540
717-656-4422
www.lanco-gap.com

Lebanon Produce Auction

166 W. Reistville Rd., Myerstown, PA 17067
717-949-2643
www.lebanonproduceauction.com

Leola Produce Auction

135 Brethren Church Rd., Leola, PA 17540
717-656-9592
www.leolaproduceauction.com

Maplewood Produce Greenhouse *see ad on page 20*

8564 Old Scotland Rd., Shippensburg, PA 17257
717-532-3278

Market Farm Implement *see ads on page 4 & 10*

257 Fawn Hollow Rd., Friedens, PA 15541
814-443-1931
www.MarketFarm.com

Marrone Bio Innovations *see ad on page 11*

1540 Drew Ave., Davis, CA 95618
717-877-7105
www.marronebio.com

Martin's Produce Supplies *see ad on page 22*

627 Britton Rd., Shippensburg, PA 17257
888-381-8641 fax – 717-532-5872
www.martinsproducesupplies.com

Martin's Repair Shop *see ad on page 8*

28 E. Trout Run Rd., Ephrata, PA 17522
717-733-3015, fax – 717-733-9618

Marvel Plastic Mulch-Irrigation, Robert

2425 Horseshoe Pike, Annville, PA 17003
800-478-2214, fax – 717-838-0978
www.RobertMarvel.com

Mechanical Transplanter Co. *see ad on page 7*

1150 Central Ave., Holland, MI 49423-5230
800-757-5268, fax – 616-396-3619
www.mechanicaltransplanter.com

MidAtlantic Farm Credit *see ad on page 25*

45 Aileron Ct, Westminster, MD 21157
888.339.3334
www.maafc.com

Morrison's Cove Produce Auction

174 Windy Acres Ln., Roaring Springs, PA 16673
814-793-9384

Morrissey Insurance Inc. , Bernard *see ad on page 25*

890 N. Reading Rd., Ephrata, PA 17522
800-422-8335, fax - 717-336-3729
www.insuringyourfuture.com

Nolt's Greenhouse Supplies *see ad on page 7*

151 E. Farmersville Rd., Ephrata, PA 17522
717-354-8376
www.noltsgreenhousesupplies.com

Nolt's Produce Supplies *see ads on pages 7, 9 & 15*

152 North Hershey Ave., Leola, PA 17540
717-656-9764
www.noltsproducesupplies.net

Nourse Farms, Inc. *see ad on page 20*

41 River Rd. South Deerfield, MA 01373
413-665-2658, fax - 413-665-7888
www.noursefarms.com

Outstanding Seed Co. LLC *see ad on page 13*

PO Box 202, Monaca, PA 15061
877-248-4567
www.outstandingseed.com

Oxford Produce Auction

200 Union School Rd., Oxford, PA 19363
610-392-2722

PA Farm Markets, LLC

4184 Dorney Park Rd., Room 104, Allentown, PA 18104
610-391-9840
www.pafarm.com

PA Service & Supply

417 Oak Hill Rd, Biglerville PA 17307
717-334-6129
www.facebook.com/paserviceandsupply

Penns Creek Welding & Manufacturing *see ad on page 6*

1340 Broadway Road, Winfield, PA 17889
570-837-1197
www.pennscreekwelding.com

Penna. Department of Agriculture *see ad on page 23*

2301 N Cameron St., Harrisburg, PA 17110-9408
717-783-8462
www.keepPAGrowing.com

PA Preferred Program

2301 N Cameron St., Harrisburg, PA 17110-9408
717-705-9511
www.papreferred.com

Penna. Ass'n. for Sustainable Ag. *see ad on page 27*

PO Box 419, Millheim, PA 16854
814-349-9856, fax - 814-349-9840
www.psafarming.org

Penna. Vegetable Marketing and Research Program

see ad on page 33
2301 N. Cameron St., Harrisburg, PA 17110
717-694-3596
www.paveggies.org

VENDORS BY NAME

Pequea Planters

561 White Horse Rd., Gap, PA 17527
717-442-4406
www.pequeaplanters.com

Pirrung Auctioneers, Inc. *see ad on page 26*

PO Box 607; 2731 East Maple Street; Wayland, NY 14572
585-728-2520, fax - 585-728-3378
www.pirrunginc.com

ProducePackaging.com *see ad on page 16*

PO Box 609; 20 Market St., Bangor, PA 18013
800-644-8729
www.producepackaging.com

Putnam Plastics

255 S. Alex Rd., West Carrollton, OH 45449
800-457-3099
www.putnamfarm.com

Rain-Flo Irrigation *see ad on page 5*

929 Reading Rd., East Earl, PA 17519
717-445-3000, fax - 717-445-8304
www.rainfloirrigation.com

Re-Divined *see ad on page 18*

142 Black Swamp Rd, Bainbridge, PA 17502
717-875-6644 grafted@redivined.net
www.redivined.weebly.com

Rimol Greenhouse Systems *see ad on page 22*

40 London Derry Tpk., Hooksett, NH 03106
717-606-8021, fax - 603-629-9023
www.rimol.com

Rupp's Seeds *see ad on page 21*

17919 Road B, Wauseon, OH 43567
419-337-1841, fax - 419-337-5491
www.ruppseeds.com

Saylor's Farm Products *see ad on page 16*

17319 Rt 68, Sligo, PA 16255
814-745-2306
www.saylorsfarm.com

SeedWay *see ad on page 17*

99 Industrial Rd., Elizabethtown, PA 17022
800-952-7333, fax - 717-367-0387
www.seedway.com

Shippensburg Produce Auction

1120 Ritner Hwy., Shippensburg, PA 17257
800-346-2334
sauctioncenter.com

Smicksburg Produce Auction

1526 Barnard Rd., Smicksburg, PA 16256

Which is Which? Are They the Same?



Pennsylvania Vegetable Growers Association

The Pennsylvania Vegetable Growers Association (PVGA) is the voluntary association of growers that publishes this newsletter, sponsors the Mid-Atlantic Fruit and Vegetable Convention, and provides other grower educational resources. It helps fund research with profits from its Farm Show food booth.

While both groups work together to fund practical vegetable research and promote the vegetable industry, they are completely separate organizations controlled by separate boards – PVGA by its elected Board of Directors and PVMRP by its Board of growers appointed by the state Secretary of Agriculture.

William Troxell serves as the staff person for both groups and they share the same phone number, but they are two separate groups.



PENNSYLVANIA VEGETABLE MARKETING & RESEARCH PROGRAM

The Pennsylvania Vegetable Marketing and Research Program (PVMRP) is the mandatory state check-off program for all growers with 1 acre of field or 1,000 sq. ft. of greenhouse/high tunnel production. It funds research and promotes PA vegetables.

VENDORS BY NAME

Snyder County Produce Auction

6130 S. Susquehanna Trail, Port Trevorton, PA 17864
570-374-0284 fax 570-374-0693
www.snydercountyproduce.com

Stand'N Plant *see ad on page 4*

95 Rose Rd., Saltsburg, PA 15681
724-639-3965 or 724-349-5167
www.standnplant.com

Statewide Bag Service *see ad on page 18*

31 Schwalm Road Tower City PA 17980
717-647-2623
www.tallmanpotatoes.com

Stokes Seeds

Box 548, Buffalo, NY 14240
800-263-7233, fax – 888-834-3334
www.stokeseeds.com

Sugar Valley Produce Auction

702 South Mill St., Loganton, PA 17747
570-725-2000

Sunnyburn Produce Auction

101 Atkins Rd., Airville, PA 17302
717-862-3010

Tew Manufacturing Corp. *see ad on page 10*

PO Box 87; 470 Whitney Rd.; Penfield, NY 14526
800-380-5839, fax 585-586-6083
www.tewmfg.com

Texpak

130 Hyde Park Rd., Franklin Square, NY 11010
800-645-3416
www.texpack.com

New Wilmington Produce Auction

3238 State Route 208
New Wlilmington, PA 16142
724-946-8540

Weaverland Produce Auction

485 Quarry Rd., New Holland, PA 17557
717-355-0834

Wes Stauffer Engine and Equipment *see ad on page 6*

23 Pleasant Valley Rd., Ephrata, PA 17522
717-738-4215
www.wesstauffer.com

Woodhouse Co. , J. S.

572 Industrial Dr. Lewisberry PA 17339
717-938-5100 fax – 413-732-3786
www.jswoodhouse.com



The Pennsylvania Vegetable Growers Association holds the trademark for the "Pennsylvania Simply Sweet Onion", a premium brand of Pennsylvania-grown sweet onions. The Association licenses growers to grow certain varieties under specified conditions (plastic mulch with drip irrigation). Onions grown by licensed growers under these terms and which meet certain quality standards are allowed to be marketed as "Simply Sweets". For further information on how to grow "Simply Sweets"; contact PVGA at 717-694-3596 or pvga@pvga.org. You can also visit www.pennsylvaniasimplysweetonions.com



VENDORS BY NAME



PENNSYLVANIA VEGETABLE MARKETING & RESEARCH PROGRAM

2301 N. Cameron St., Harrisburg, PA 17110 | 717-694-3596 | pvrmp@embarqmail.com | PAVeggies.org

Step Up Your Marketing

with these Point of Purchase Materials designed especially for Pennsylvania Growers



The Pennsylvania Vegetable Marketing and Research Program offers the above selection of point-of-purchase items. Most feature the “PA Produce” logo or tagline to clearly identify your market’s produce as locally grown with these attractive and professionally-designed pieces. Check out these items and the other farmer resources from the Program in the “Farmer’s Toolkit” at www.paveggies.org or call 717-694-3596

MEMBERSHIP RENEWAL FORM

*Pennsylvania Vegetable Growers Association***2021 Membership Renewal Form**

Name _____

Farm Name _____

Address _____

City/State _____ Zip Code _____

PA County _____ Telephone ____/____/____ Cell Phone ____/____/____

Facsimile ____/____/____ Electronic Mail _____

Business Information Please check all that apply.

Grower (owner-operator) Retail Wholesale
 Fresh Market Vegetables Processing Vegetables Greenhouse Vegetables Potatoes
 Small Fruit Bedding Plants Cut Flowers Tree Fruit Wine Grapes
 Grower Employee Supplier (equipment, chemicals, etc.) Processor Other _____

2021 PVGA Membership Dues

Regular Membership Dues increase to \$55 after February 11. \$50.00 _____

Open to all owner, operators and employees of vegetable, potato and berry farm operations, processing firms and supply companies. All memberships include newsletter subscription.

Associate Regular Membership Includes newsletter subscription. \$30.00 _____

Must be one of the following - circle one: Student Retired University Staff Extension Agt.

Keystone Membership An optional membership category open to vegetable and berry farming operations, processing firms, and supplier firms. Includes newsletter subscription.

Dues based on gross income from vegetable potato or berry industries. Any member paying \$75 or more in dues will be considered a Keystone Member. The following rates are only suggestions.

\$75 for up to \$75,000 \$100 for \$75,000 to \$150,000 \$150 for \$150,000 to \$225,000
 \$200 for \$225,000 to \$500,000 \$275 for \$500,000 to \$1,000,000 \$375 for over \$1,000,000

Associate Keystone Membership Must be a family member or employee of a Keystone Member. \$30.00 _____

Country Folks Grower -Check here to receive a free monthly subscription to this publication _____

Total Enclosed _____ Payment by check or money order only - make checks payable to "PVGA"

Mail this registration form and payment to: **PVGA, 815 Middle Road, Richfield, PA 17086-9205** 717-694-3596 - phone and fax

Thank you for your membership in PVGA that brings you

- Subscriptions to the *Plus the American Vegetable Grower magazine and the Vegetable Growers News*

Besides making you part of the organization that:

- Sponsors the Mid-Atlantic Fruit and Vegetable Convention
- Also sponsors local grower meetings and tours
- Provide support for vegetable and small fruit research (over \$1.25 million in the last 32 years!)
- Is the voice of the Pennsylvania Vegetable, Potato and Berry industries

IMPORTANT TELEPHONE NUMBERS

Poison Control Center 800-222-1222

Agri-Service Agency – health and worker's compensation insurance for PVGA members 877-466-9089

Integrated Pest Management Hotline & Pesticide Update Credit Information 800-PENN-IPM

Penn State Cooperative Extension Offices

Adams	717-334-6271
Allegheny	412-263-1000
Armstrong	724-548-3447
Beaver	724-774-3003
Bedford	814-623-4800
Berks	610-378-1327
Blair	814-940-5989
Bradford	570-265-2896
Bucks	215-345-3283
Butler	724-287-4761
Cambria	814-472-7986
Cameron	814-486-3350
Carbon	570-325-2788
Centre	814-355-4897
Chester	610-696-3500
Clarion	814-223-9028
Clearfield	814-765-7878
Clinton	570-726-0022
Columbia	570-784-6660
Crawford	814-333-7460
Cumberland	717-240-6500
Dauphin	717-921-8803
Delaware	610-690-2655
Elk	814-776-5331
Erie	814-825-0900
Fayette	724-438-0111
Forest	814-755-3544
Franklin	717-263-9226
Fulton	717-485-4111
Greene	724-627-3745
Huntingdon	814-643-1660
Indiana	724-465-3880
Jefferson	814-849-7361
Juniata	717-436-7744
Lackawanna	570-963-6842
Lancaster	717-394-6851
Lawrence	724-654-8370
Lebanon	717-270-4391
Lehigh	610-391-9840
Luzerne	570-825-1701
Lycoming	570-433-3040
McKean	814-887-5613
Mercer	724-662-3141
Mifflin	717-248-9618
Monroe	570-421-6430
Montgomery	610-489-4315
Montour	570-784-6660
Northampton	610-813-6613
Northumberland	570-988-3950
Perry	717-582-5150
Philadelphia	215-471-2200
Pike	570-296-3400
Potter	814-274-8540
Schuylkill	570-622-4225
Snyder	570-556-4760
Somerset	814-445-8911
Sullivan	570-928-8941

Penn State Cooperative Extension Offices *(continued)*

Susquehanna	570-278-1158
Tioga	570-724-9120
Union	570-556-4760
Venango	814-437-7607
Warren	814-563-9388
Washington	724-228-6881
Wayne (extension 4110)	570-253-5970
Westmoreland	724-837-1402
Wyoming	570-836-3196
York	717-840-7408

Pennsylvania Department of Agriculture

Pesticide Regulations, Worker Protection Standards, Chemsweep Program, Plant Inspection, Food Safety Inspection - contact nearest regional office

Northwest - Meadville	814-332-6890
North Central - Montoursville	570-433-2640
Northeast- Tunkhannock	570-836-2181
Southwest – Greensburg	724-832-1073
Southwest Central - Martinsburg	814-793-1849
Southeast Central - Harrisburg	717-346-3223
Southeast - Creamery	610-489-1003
Seasonal Farm Labor	717-787-4315
Market Development	717-783-8462
PA Preferred Program	717-705-9511
Food Safety	717-787-4315
Plant Industry - Pesticides	717-787-4843
Fruit and Vegetable Inspection	717-787-4315
Farmers' Market Nutrition Program	717-772-2693
Ag Workforce Development	717-346-0426

Pennsylvania Department of Labor & Industry

General Information	717-787-5279
Workers' Compensation	800-482-2383
Right to Know	717-783-1826
Workforce Development	717-787-6521

Pennsylvania Vegetable Marketing and Research Program

717-694-3596

Pennsylvania Vegetable Growers Association

717-694-3596

***If you do not know who to call,
call PVGA at 717-694-3596
We can help find an answer.***



Pennsylvania Vegetable Growers Association

815 Middle Road
Richfield, Pennsylvania 17086-9205
717-694-3596
pvga@pvga.org
www.pvga.org

Change Service Requested

PRESORTED STANDARD
U.S. POSTAGE
PAID
HARRISBURG PA
PERMIT NO. 533



What makes a successful Produce Auction?

Growers individually doing their best to grow a variety of top-quality produce and *COLLECTIVELY* bringing it to a central location to attract a large group of buyers willing to pay top dollar for the best produce – *in other words, growers working together to benefit growers.*



Growers Working Together to Benefit Growers is also the reason PVGA exists.

We need YOUR membership to continue to serve YOU and your fellow Pennsylvania growers by providing this monthly newsletter and our weekly email updates, sponsoring the Mid-Atlantic Fruit and Vegetable Convention and local grower meetings, funding vegetable and small fruit research, and promoting and representing the interests of Pennsylvania growers. Join today!



PVGA – Growers Working Together to Benefit Growers

See page 2 for further details and page 34 for a membership form.