

PENNSYLVANIA
VEGETABLE GROWERS

NEWS

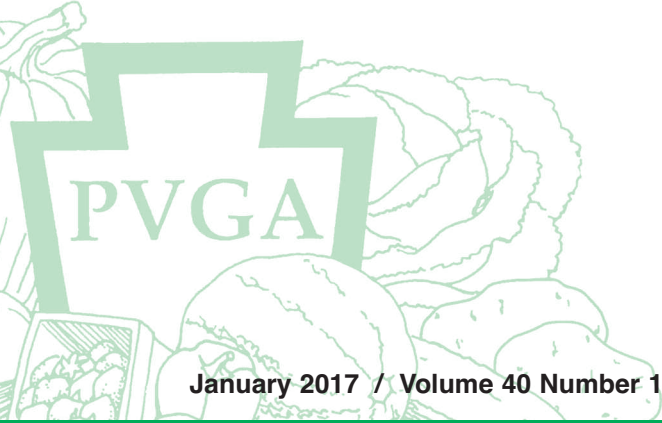

January 2017 / Volume 40 Number 1

for the commercial vegetable, potato and berry grower

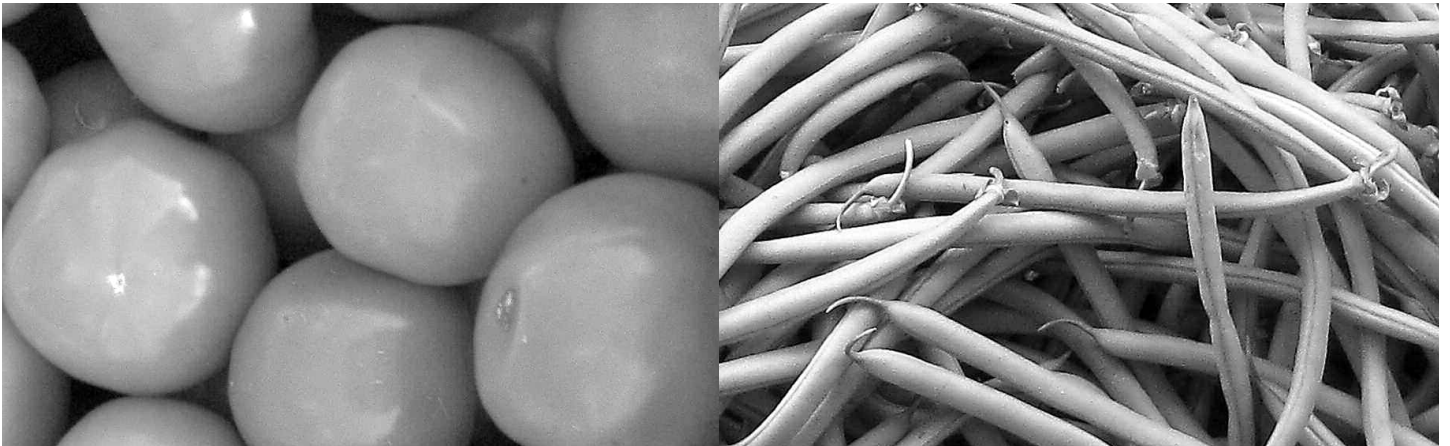

2017 Buyers' Guide



GENERAL

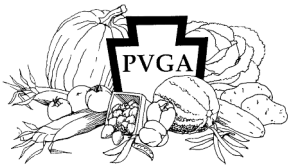

**Pennsylvania
Vegetable Growers
Association**

*An association of
commercial vegetable,
potato and berry growers.*

President

Robert Shenot '16
Wexford

First Vice President

David Miller '17
York

Second Vice President

Jonathan Strite '16
Harrisburg

Secretary-Treasurer

William Reynolds '16
Waynesboro

Past President

Brian Campbell '18
Berwick

Directors

Fred Dymond III '17
Dallas

Christopher Harner '17
State College

Lois Klinger '16
Catawissa

David King '16
Bakerstown

Kenneth Martin '17
New Berlin

Eric Oesterling '18
New Alexandria

Michael Orzolek '18
State College

John Shenk '17
Lititz

Jeffrey Stoltzfus '17
Atglen

Thomas Strzelecki '18
Wapwalopen

Randy Treichler '18
Three Springs

Mark Troyer '18
Waterford

Timothy Weiser '16
York Springs

Executive Secretary
William Troxell
Richfield

Dear Pennsylvania Grower

This special edition of the Pennsylvania Vegetable Growers News, the monthly newsletter of the Pennsylvania Vegetable Growers Association, has been prepared as a source book of information for you, the Pennsylvania grower. We have listed various vendors of equipment, supplies and services who deal with Pennsylvania growers. Keep this booklet handy to refer to throughout the year.

We also ask you to consider joining the Pennsylvania Vegetable Growers Association. If you are a vegetable, potato or berry grower, you should belong to the organization that represents your industry. Founded in 1926, PVGA has been serving growers like you for 90 years. Your membership will strengthen the Association's position as the official voice of the vegetable, potato and berry industries and will also provide numerous benefits to you.

For example, each year the Association co-sponsors the Mid-Atlantic Fruit and Vegetable Convention in Hershey. This meeting is one of the most respected vegetable meetings on the East Coast and offers three days of concurrent sessions on processing vegetables, fresh market vegetables, potatoes, small fruits, bedding plants, direct marketing, organic vegetables, cut flowers and other specialty crops. As a member of the Association, you help make this convention possible and you receive reduced registration fees. PVGA also sponsors field days at Penn State's research plots, and regional grower meetings.

As a member, you will receive monthly subscriptions to this newsletter, the **Pennsylvania Vegetable Grower News**, to keep you informed on what is happening in the vegetable, potato and berry industries. PVGA members also receive free subscriptions to the **American Vegetable Grower** and the **Vegetable Growers News**.

Last year, the Association gave over \$81 per member of the Association or a total of \$81,000 to Penn State University researchers to sponsor practical vegetable and berry research. This was made possible through the Association's food booths at the Pennsylvania Farm Show and Ag Progress Days. These food booths also help to promote the vegetable and berry products you produce.

PVGA represents the interests of the vegetable, potato and berry industries on both state and federal issues. The Association contacts legislators regularly on issues that affect our growers. Special attention is given to food safety, state budget appropriations, labor, deer crop damage, irrigation (water use), and pesticides as they relate to horticultural growers.

The Association is also a member of the State Council of Farm Organizations, the United Fresh Produce Association and the Penn State Agricultural Council, again with the purpose of representing the vegetable, potato and berry industries in the public arena and to Penn State University researchers and administrators.

The bottom line is this. A \$50 membership in the Pennsylvania Vegetable Growers Association is worth every penny. For each member, about \$81 is given to research, about \$22 is spent to publish the **Pennsylvania Vegetable Growers News**, and up to \$85 per person can be saved on three-day registration fees for the Mid-Atlantic Fruit and Vegetable. That adds up to \$188 or over triple the return on your dues investment.

Use the form on page 30 of this newsletter to join today!

The **Pennsylvania Vegetable Growers News** is the official monthly publication of the Pennsylvania Vegetable Growers Association, Inc., 815 Middle Road, Richfield, PA 17086-9205
phone and fax - 717-694-3596, email - pvga@pvga.org website - www.pvga.org

Our Mission:

The Pennsylvania Vegetable Growers Association serves Pennsylvania's commercial vegetable, potato and berry growers through education, research, advocacy and promotion.

Our Vision:

The Pennsylvania Vegetable Growers Association will be the driving force in ensuring the future viability of the commercial vegetable, potato and berry industries in Pennsylvania.

Inquiries about membership, this publication or advertising rates should be directed to William Troxell, Executive Secretary, at the above addresses.

GENERAL

MID-ATLANTIC

fruit & vegetable convention



January 31 to February 2, 2017

Hershey Lodge and Convention Center – Hershey, Pennsylvania

The Premier Grower Meeting in the Northeast

***Trade Show with over 160 exhibitors
featuring the latest in grower and direct marketing supplies.***

Pre-Convention Workshops & Tour

***January 30 – Farm Market Bus Tour, FSMA Grower Training, Recall Readiness
Hops Production, Greenhouse Vegetable Production, Vegetable Grafting
Cider Symposium, Tree Fruit Grafting, PA Pesticide License Training***

***Educational Sessions all three days– over 40 sessions
featuring expert speakers from across the nation!!!***

January 31

***Fall Ornamentals, Vine Crops, Organic Vegetables, Broccoli,
Crucifers, Asparagus, Snap Beans, Hydroponics, Wholesale Marketing, Market Trends,
Farm Transitions, Changing Climate, Pome Fruit, Keynote***

February 1

***High Tunnels, Sweet Corn, General Vegetables, Greenhouse Ornamentals,
Small Fruit, Cover Crops, Onions, Agritourism & Direct Marketing, Marketing 101,
Stone Fruit, Tree Fruit, Wine Grapes, Spanish***

February 2

***Small Fruit, Tree Fruit, Tomatoes, High Tunnels, Potatoes, CSAs, Social Media and Advertising
Strategies, Specialty Vegetables, Cut Flowers, Leafy Greens***

For information visit www.mafvc.org or call 717-694-3596

Registration fees range from \$65 to \$150.

PVGA members receive substantial discounts. Save more by pre-registering.

Walk-in registration is available.

VENDORS BY CATEGORY

Vendors are listed below by category of the equipment, supplies or services they offer. An alphabetical listing of vendors and their addresses begins on page 25.

General Equipment

Tillage and Cultivating Equipment

- Binkley & Hurst Bros. Inc. – 800-414-4705
- Hillside Cultivator – 717-626-6194
- I & J Manufacturing – 717-442-9451
- Market Farm Implement – 814-443-1931
- Messick Farm Equipment – 800-222-3373
- Stauffer Engine and Equipment, Wes – 717-738-4215
- Woodhouse, J. S. – 717-938-5100

Planting Equipment

- Binkley & Hurst Bros. Inc. – 800-414-4705
- Black Rock Repair 717-529-6553
- I & J Manufacturing – 717-442-9451
- Market Farm Implement – 814-443-1931
- Martin's Produce Supplies – 888-381-8641
- Marvel, Robert, Plastic Mulch
800-478-2214
- Mechanical Transplanter Co.
800-757-5268
- Messick Farm Equipment – 800-222-3373
- Nolt's Produce Supplies – 717-656-9764,
661-7069
- Rain-Flo Irrigation – 717-445-3000
- Stand'N Plant – 724-639-3965
- Woodhouse, J. S. – 717-938-5100

Bedders, Bed Shapers, Drain Ditchers, Tool Bars and Accessories

- Market Farm Implement – 814-443-1931
- Nolt's Produce Supplies – 717-656-9764,
661-7069
- Rain-Flo Irrigation – 717-445-3000

Fertilizer Application Equipment

- Market Farm Implement – 814-443-1931
- Mechanical Transplanter – 800-757-5268
- Messick Farm Equipment – 800-222-3373

STAND 'N PLANT

SEEDER

Use for...

- Seeds
- Onions
- Garlic



PLANTER

Use for...

- Transplants
- Potatoes
- Bulbs



Easily plant hundreds of seeds or plants per hour into plastic covered or bare ground seed beds.

Stand 'N Plant

95 Rose Road, Saltsburg, PA 15681
Phone: 724-639-3965 or visit: www.standnplant.com

MaterMacc Precision Vacuum Planters

Finally, One Planter For All Seed!



*Plants All Size Seed from Raw Lettuce to Lima Beans!
Quick Change Row Spacings!
Quick Change Seed Variety!
Quick Fertilizer Clean Outs!
1.5 Thimble Seed Charging!*

Market Farm Implement, Inc.
814-443-1931
www.MarketFarm.com

Unmatched Singulation!



See us for your farming tools

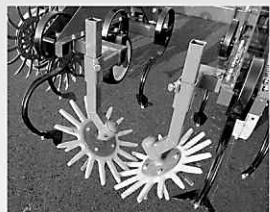

Finger Weeder

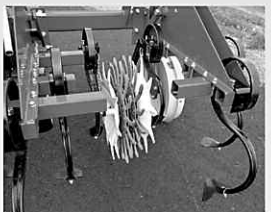

Rotary Hoe with Shield

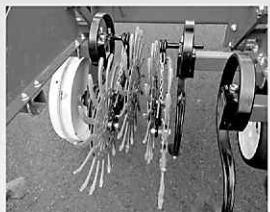

Rotary Hoe with Walking Beam

- We also carry:**
- Ground Drive Forecarts
 - Market Garden Tools
 - Mowers Can Be Ground Driven



(717) 442-9451

10 South New Holland Road, Suite 2
Gordonville, PA 17529



Rain-Flo Irrigation LLC



*Serving your irrigation needs...
Call today for our free catalog.*



Mfg. of Vegetable Machinery
Sales of Drip Irrigation & Plastic Mulch
Retail ▪ Wholesale



929 Reading Rd
East Earl, PA 17519
PH:717-445-3000
Fax:717-445-8304

VENDORS BY CATEGORY

General Equipment

Plasticulture Equipment

- CropCare – 717-738-7365
- DuBois Agrinovation – 800-667-6279
- Martin's Produce Supplies – 888-381-8641
- Market Farm Implement – 814-443-1931
- Marvel, Robert, Plastic Mulch – 800-478-2214
- Mechanical Transplanter Co. – 800-757-5268
- Nolt's Produce Supplies – 717-656-9764,
661-7069
- Rain-Flo Irrigation – 717-445-3000
- Saylor's Farm Products – 814-745-2306
- Zook's Plastic Recovery – 717-656-4422

Harvesting Equipment

- Black Rock Repair – 717-529-6553
- CropCare – 717-738-7365
- I & J Manufacturing – 717-442-9451
- Market Farm Implement – 814-443-1931
- Martin's Produce Supplies – 888-381-8641
- Messick Farm Equipment – 800-222-3373
- Nolt's Produce Supplies – 717-656-9764,
661-7069
- Rain-Flo Irrigation – 717-445-3000

BCS THE BEST TILLER ON EARTH
No Belts • No Chains • No Equal

PRE SEASON SALE

- 18" to 30" Tillers
- Models 6 to 13HP Honda Engines
- Quick Change Handle Positions
- No Time-Limit Warranty on Transmissions
- 50% Higher Tine Speed Than Competition
- FREE Quick Hitch for Attachments on 732 - 853

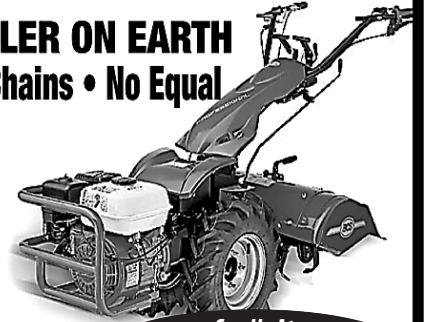

See Us At
Mid-Atlantic Fruit and Veg. Convention
Jan. 31 to Feb. 2, 2017

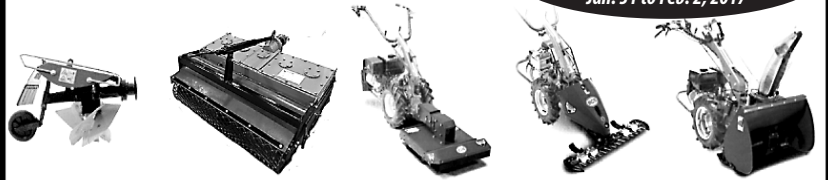

Rotary Plow Power Harrow Brush Mowers Sickle Bar Mowers Snow Throwers
Also: Flail Mowers • Chipper/Shredder • Wood Splitter • Utility Trailer

WES STAUFFER EQUIPMENT LLC
www.wesstauffer.com 717-738-4215
BCS Dealer For 30 Years!

23 Pleasant Valley Rd. East of Ephrata off Rt. 322 • Mon. & Wed. 8-5:30; Tues., Thur., Fri. 8-7 Sat. 8-3



VEGETABLE GROWERS

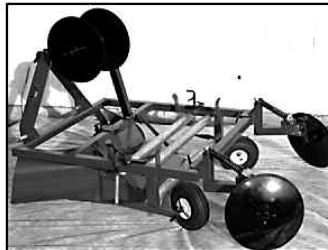

**COMPACT RAISED
BED MULCH LAYER**

- Designed for use in High Tunnels or small fields.
- 3ft. and 4 ft. models. Forms 4" high bed. 25-30 HP required.

Also Available

- Model 500 Mulch Lifters
- Super Deluxe Flatbed Mulch Layers
- HYD Drive Mulch Wrappers



**MODEL 550
HYDRAULIC RESET
MULCH LIFTER**



**MODEL P150 WATER
WHEEL PLANTER**

- Total Open Frame
- Easier to change planting wheel
- 3 pt. or pull type



**ALUMINUM HARVESTING
CONVEYORS**

Specializing in
VEGETABLE GROWING
EQUIPMENT &
SUPPLIES

Call for our
commercial growers catalog

NOLT'S PRODUCE SUPPLIES

152 N. Hershey Ave., Leola PA 17540

(717) 656-9764

MECHANICAL TRANSPLANTER COMPANY

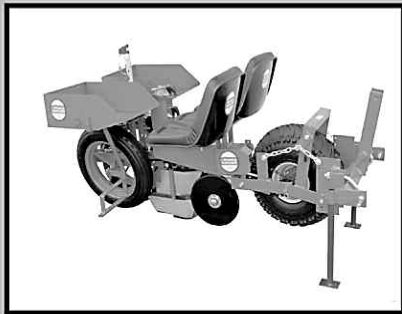

Model 1000

* Excellent for bare root and small cells. Our most popular transplanter.

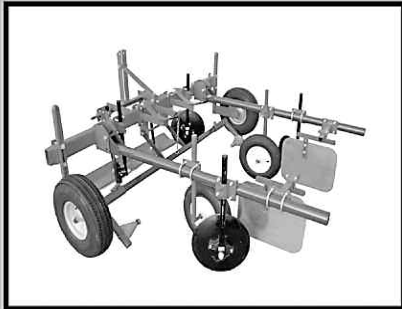

Model 90

* Lays any size mulch from 3-6 feet wide.

NEW CLEAN SEEDER



MODEL JP-1

* Excellent for small seed
* Lightweight & easy to handle
* Accurate spacing

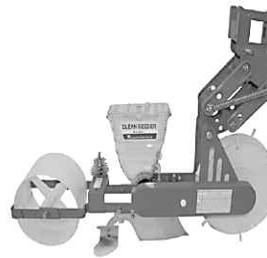

MODEL JPH

* Row spacing as close as 7"
* Mounts on 2" square toolbar

Mechanical Transplanter Company, LLC * 1150 Central Avenue * Holland, MI 49423
Phone: 616-396-8738 or 800-757-5268 * Fax: 616-396-3619
website: www.mechanicaltransplanter.com * e-mail: mtc@mechanicaltransplanter.com

3 IN 1 SOIL CONDITIONERS

Ideal For High Speed Cultivation

Perfect for nurseries, berry growers, orchards, vineyards and general cultivation work.

FEATURES:

- 3 soil conditioning tools in one machine
- Heavy-duty 20" high clearance S-Tines to penetrate and till up to 7" deep
- 6-1/2" shank spacing on all models except 4' soil conditioners which have 7-1/3" spacing
- 7" sweeps are standard optional 1-3/8" reversible points
- Spring loaded, 12" diameter rolling crumblers with serrated bars angled to finish mulching the soil

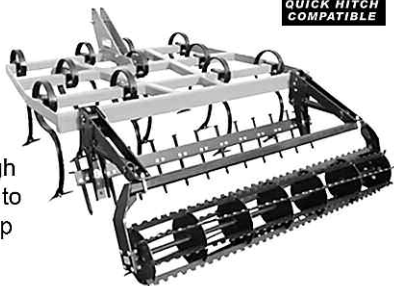

Distributed by ~ J.S. Woodhouse Co., Inc.
Phone: (413.736.5462 Fax: (413.732.3786

www.JSWoodhouse.com

Be Prepared When The Weeds Start To Grow



Hillside Cultivator Model CS

The best cultivator for strawberries and between plastic mulch.

The best cultivator for in row weed removal.

Eco Weeder



Hillside Cultivator Co. LLC

911 Disston View Dr., Lititz, PA 17543
717-626-6194 www.hillsidecultivator.com

VENDORS BY CATEGORY

General Equipment

Irrigation Equipment and Supplies

DuBois Agrinovation – 800-667-6279
 Jordan Seeds, Inc. – 651-738-3422
 Market Farm Implement – 814-443-1931
 Martin's Produce Supplies – 888-381-8641
 Marvel, Robert, Plastic Mulch. – 800-478-2214
 Nolt's Produce Supplies – 717-656-9764, 661-7069
 Rain-Flo Irrigation – 717-445-3000
 Toro-Microirrigation – 800-333-8125 3-8125
 Zook's Plastic Recovery - 717-656-4422



Pesticide Application Equipment

Black Rock Repair 717-529-6553
 CropCare – 717-738-7365
 Danville Industries – 800-662-4212
 Market Farm Implement – 814-443-1931
 Martin's Produce Supplies – 888-381-8641
 Martin's Repair Shop – 717-733-3015
 Messick Farm Equipment – 800-222-3373
 Penns Creek Welding – 570-837-1197
 Swihart Sales Co. – 800-864-4695
 Woodhouse, J. S. – 717-938-5100

Black Rock Repair LLC

Manufacturer of *farm and home sprayer*

sprayer pumps parts & service | pressure washer sales & service

LEROY or LEVI • 717.529.6553

hydraulic hoses | general welding & repair
 produce equip | UPS service | sprayer manufacturing

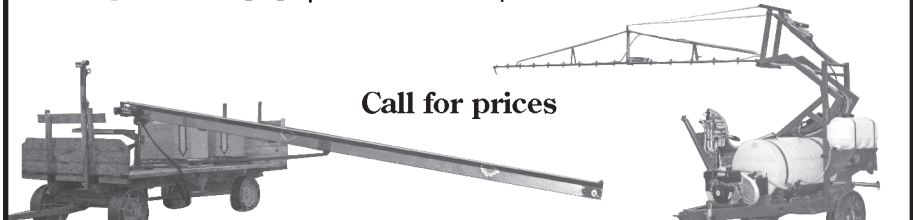

Call for prices

858 Pumping Station Rd | Kirkwood, PA 17536



SWIHART
 Sales Company
 – Mist Sprayers –

SPRAY
 INNOVATIONS



American Made

We offer a complete line of low volume mist blowers.

Low Maintenance
 High Performance

Excellent for spraying:
 VEGETABLES, vineyards,
 orchards, nurseries, Christmas
 trees, mosquitoes, cattle,
 chicken houses, etc.

References
 available in
 your area

For free brochure contact:
Swihart Sales Co.

7240 County Road AA, Quinter, KS 67752

785-754-3513 or 800-864-4595

www.swihart-sales.com

VENDORS BY CATEGORY



Multivator Cultivators

A **MULTIVATOR** is a high-clearance rotary tillage machine designed for inter-row cultivation of vegetable, nursery, fruit & field crops. Mounted on 3 pt. hitch of tractor & powered by the PTO, it transmits power to a selected number of rotary tiller heads equipped with blades that cultivate ground between rows of growing crops. Weed growth is eliminated & crusted or compacted soils are transformed into tilth.

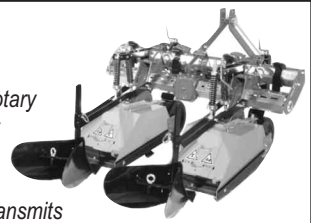

Distributed by:
J.S. Woodhouse Co., Inc. Since 1843
WOODHOUSE
572 Industrial Dr., Lewisberry, PA 17339
717-938-5100 • Fax: 717-938-8769
www.jswoodhouse.com • email: info@jswoodhouse.com



Jacto cannon sprayers provide increased coverage in dense foliage and broadleaf crops such as pumpkins, sweet corn, tomatoes and strawberries. 7 different models available to fit every size farm and crop combination. Also works great in blueberries and raspberries to combat the spotted wing drosophila.



Jacto airblast sprayers come in 9 different sizes from 50 to 1000 gallons. Including 4 models with towers for increased efficiency in dense vertical crops such as grapes, blueberries and Christmas trees. Three models can be safely operated with 20HP tractors.



Jacto backpacks are ergonomically designed for ease of operator use and comfort. These backpacks are ideal for the smaller grower who does not want to use a tractor mounted sprayer or for use in cold frames, greenhouses and spot spraying. 4 models to choose from including two with paddle agitation for wettable powders such as Surround.



For more information or the name of your local dealer contact JS Woodhouse

J.S. Woodhouse Co., Inc. Since 1843
WOODHOUSE
email: info@jswoodhouse.com
www.jswoodhouse.com

J.S. WOODHOUSE CO., INC
Serving: PA, DE, MD, NJ, NY & New England
West Springfield, MA • 413-736-5462
Syracuse, NY • 315-463-5201
Lewisberry, PA • 717-938-5100
Fairfield, ME • 207-453-7788

CROP CARE

Shielded Sprayer



Experience the quality, Enjoy the results.



PR2500 Plastic Mulch Lifter-Wrapper



PA1600 Picking Assistant



25' Single-Sided Boom Produce Sprayer

CropCareEquipment.com | Lititz, PA
Manufactured by PBZ LLC, a Paul B. Zimmerman, Inc. company

Please contact your local CropCare® dealer with any questions.

Cedar Grove Farm Store
Shippensburg, PA....717-532-7571

Martin's Repair Shop LLC
Ephrata, PA.....717-733-3015

VENDORS BY CATEGORY

General Equipment

Grading, Packing and Storage Equipment

- Black Rock Repair – 717-529-6553
- Market Farm Implement – 814-443-1931
- Martin's Produce Supplies – 888-381-8641
- Nolt's Produce Supplies – 717-656-9764, 661-7069
- Rain-Flo Irrigation – 717-445-3000
- Tew Manufacturing Corp. – 800-380-5839

Wholesale Labeling Equipment

- Texpak – 800-645-3416

Refrigeration Equipment

- Arctic Refrigeration – 585-343-2678
- KoolJet Refrigeration – 866-748-7786



TEW MANUFACTURING CORP.

Fruit & Vegetable Cleaning & Sizing Equipment

**Quality Latex & Poly Sponge
Drying Donuts**

Tuff Foam® Protective Padding

Brushes, Bearings, Sizing Chains

Scrubber Rubber Plain & Fabric Back

**Stanhay, Tew Jr.™, Tew Mx™
Vegetable Seed Planters & Parts**

**FOR MORE INFORMATION CALL
1-800-380-5839**

TEW MFG. CORP. 585-586-6120
P.O. BOX 87 FAX: 585-586-6083
PENFIELD, NY 14526 www.tewmfg.com

**Refrigerated and
Ventilated Cooling
Systems for Fruit and
Vegetable Storages**

- COMMERCIAL REFRIGERATION
- DESIGN, SALES AND SERVICE
- SERVING AGRICULTURE
FOR OVER 65 YEARS

Free Consultation and Quote
Call Mike Mager at 585-343-2678

See Us At
Booth #78 At
The Mid-Atlantic
Fruit & Vegetable
Convention



26 Cedar Street, Batavia, NY 14020
www.arcticrefrigeration.com

SOLO SPRAYERS

We carry a full line of Solo Sprayers
from hand pump to engine driven units.
Call us today for your spraying needs.

We ship UPS

PARTS • SALES • SERVICE

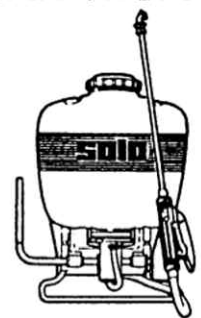

27 West Mohler Church Road,
Ephrata, PA 17522
Ph: 717-733-3015





ROBERT MARVEL PLASTIC MULCH, LLC

Plastic Mulch Film

Embossed, Smooth and Biodegradable.

Equipment

Plastic Mulch Layers
Plastic Mulch Lifters
and Planters.

Drip Irrigation

Carrying A Full Line Of
Drip Irrigation Tapes,
Filters,
Pressure Regulators,
Fittings, In-Line Drip
Tube and More.

Greenhouse Cover

Solaroof Woven
Greenhouse Cover,
Tufflite IV - 6 mil.,
Tufflite IR - 6 mil.

Floating Row Covers

Earlier Harvest,
Insect Protection and
Frost Protection.
Also Available in Custom
Made Sizes To Fit Your
Fields.

Avian Control

The Most Effective Liquid
Bird Repellent Available.

www.robertmarvel.com

OR

Call Toll Free 1-800-478-2214

We accept Visa, Mastercard and Discover

VENDORS BY CATEGORY

General Supplies

Mulching/Row Covers

- DuBois Agrinovation – 800-667-6279
- Gristmill Vegetable Farm – 717-354-8444
- Harris Seeds – 800-544-7938
- Jordan Seeds, Inc. – 651-738-3422
- Martin's Produce Supplies – 888-381-8641
- Marvel, Robert, Plastic Mulch
800-478-2214
- Mechanical Transplanter Co.
800-757-5268
- Nolt's Produce Supplies – 717-656-9764,
661-7069
- Rain-Flo Irrigation – 717-445-3000
- Schwartz & Sons – 800-523-3500

**SEE VIDEOS OF SPRAYERS IN ACTION ON UPDATED WEBSITE!
NEW HYDRAULIC FOLD SPRAYER FEATURES
AIRBAG BOOM SUSPENSION!**



Sprayer Models • 200 Gallon Manual Fold • 300 Gallon Manual Fold • 400 Gallon Manual Fold • 400 Gallon Hydraulic Fold

PENNS CREEK MFG.

1340 Broadway Rd., Winfield, PA 17889

570-837-1197

www.pennscreekwelding.com

BUILDERS OF DEPENDABLE ECONOMICAL VEGETABLE SPRAYERS



Authority in Refrigeration for Food Processing and Agricultural Industry

- THRU-THE-WALL
- ROOF-MOUNTED
- PORTABLE
- HYDROCOOLERS
- CUSTOM DESIGNS
- BLAST FREEZERS
- CHILLERS
- GREENHOUSE COOLERS

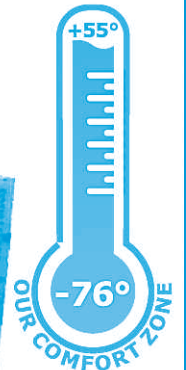

Made in North America

1.866.748.7786 ONE PIECE DESIGN FREE COOLING



Floating Row Cover 2017 Stock Sizes

.56 oz. per sq. yd.	.91 oz. per sq. yd.	1.25 oz. per sq. yd.
7'x500'	7'x800'	50'x500'
7'x1000'	14'x800'	45'x500'
10'x500'	26'x800'	40'x500'
14'x1000'	32'x500'	30'x500'
22'x1000'	39'x800'	15'x1000'
26'x1000'	42'x500'	10'x2000'
30'x1000'	50'x500'	5'x3000'
36'x1000'		and custom sizes
40'x1000'		
50'x500' & 50'x1000'		

- ✓ Quality Cover
- ✓ Discount Prices
- ✓ Trailerload Quantities In Stock

Gristmill Vegetable Farm

201 Gristmill Rd., New Holland, PA 17557

Phone / Fax 717-354-8444

**Ground Cover
Black, Green & White**

Also Anchor Bags,
Tomato Twine
and Sod Staples

Save time, save money, save the planet.



Presenting the "Bio360 Biodegradable & Compostable Mulch Film".

"Bio360 Biodegradable and Compostable Mulch Film" made of Mater-Bi, completely disappears without a trace and without leaving any toxic residue. It also saves both time and money because you don't have to remove it. What's more, you'll be helping the planet. It also promotes rapid root growth and eliminates weeds. So it's a win-win situation! Ask one of our representatives how much you can save using this revolutionary new product.

Nolt's Produce Supplies
717-656-9764 - Leola, PA
noltsproucesupplies.net

For other regions, contact US
1-844-4BIO360 (1-844-424-6360)



VENDORS BY CATEGORY

General Supplies

Fertilizer

Blackmore Co. – 800-874-8660
 CSI Chemical – 800-247-2480
 Fertrell Company – 717-367-1566
 Grower Mineral Solutions – 800-437-4769
 Growth Products – 800-648-7326
 Martin's Produce Supplies – 888-381-8641
 Nolt's Produce Supplies – 717-656-9764, 661-7069
 Perdue AgriRecycle – 302-628-2361
 Timac Agro USA – 800 545 5474

Pesticides/Plant Growth Regulators

Growth Products – 800-648-7326
 Martin's Produce Supplies – 888-381-8641

Biocontrols – Beneficial Insects

IPM Laboratories – 315-497-2063

Wildlife/Bird Damage Control Products

DuBois Agrinovation – 800-667-6279
 JWB Marketing – 800-555-9634



Produce Supplies

- Seeds
- Potting Soil
- Peat Moss
- Greenhouses
- Fertilizers
- Irrigation
- Pots & Planters
- Row Covers
- and much more!

**Call now for your
Free 2017 Catalog!**

1.888.381.8641
(717) 532-5918



627 Britton Rd, Shippensburg, PA 17257

Visit us online: www.MartinsProduceSupplies.com



CRAIG LAMBERT
 (917) 416-4588
 clambert@growthproducts.com
 www.growthproducts.com

NEFARIOUS! Break the Resistance Barrier

Whether you are a strawberry, blueberry, tomato, pumpkin or pepper grower, fungicide resistance issues are constant and growing. Leading universities are focused now on the use of biologicals incorporated into programs that will boost the efficacy of chemicals at often lower rates.

HEROIC! Biorationals!

Growth Products has worked with specialist at Un. of Florida and Biological Applied Research Inc., Raleigh, NC for two years of field trials on strawberries to control botrytis and other fungal disease. At the Un. Of Arizona and UC Davis trials were completed on powdery mildew. Environmentally-friendly biorationals, bio-innovations, technically-advanced liquid fertilizers, micronutrients are also available from Growth Products. Our list includes soil inoculants, phosphites, chelated micronutrients, an exclusive foliar feed slow release nitrogen and Companion®, our effective biological fungicide formulated for agriculture and horticulture. With 30 years behind our technologies.

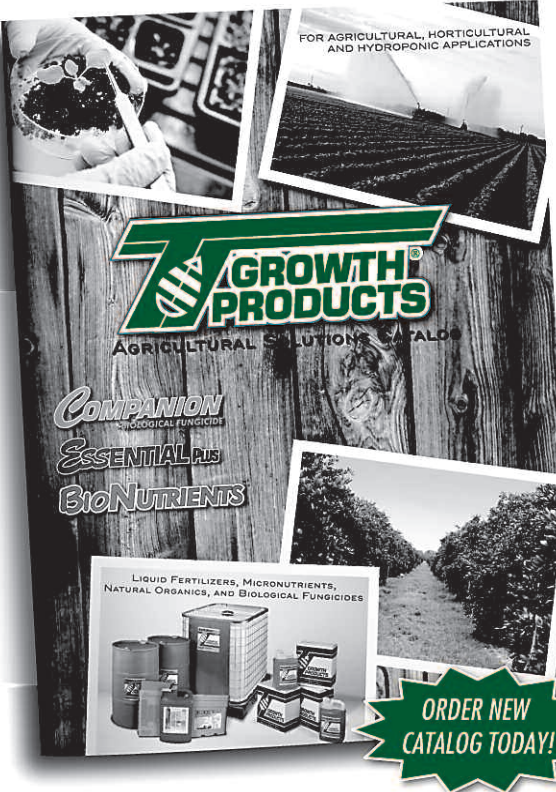

- TKO Phosphite (0-29-26) or (0-0-26)
- MicroTech CT with 7 Chelated Micronutrients
- MicroTech AG with 4 Chelated Micronutrients
- Nitro-30 (30-0-0) Slow Release Nitrogen
- Companion® Biological Fungicide
- Companion® Dry WP Fungicide OMRI
- BioNutrients 8-1-9 WSDA

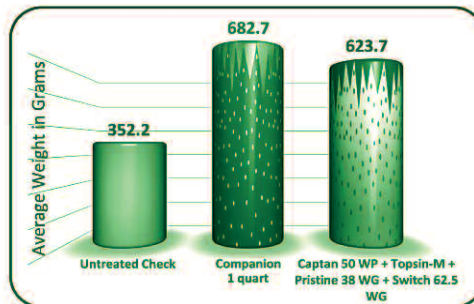

Control of Anthracnose Fruit Rot
 Average Fruit Weight (Grams)
 Biological Applied Research
 Elm City, NC

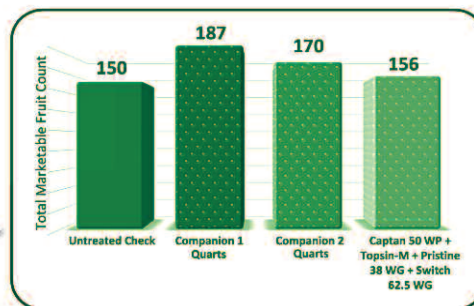

Control of Anthracnose Fruit Rot
 Total Marketable Fruit Count
 Biological Applied Research
 Elm City, NC

80 Lafayette Ave. White Plains, NY 10603 • Toll Free: (800) 648-7626
 Email: questions@growthproducts.com • Web: www.growthproducts.com



VENDORS BY CATEGORY

General Supplies

Containers and Packaging Supplies

- Blackmore Co. – 734-483-8661
- DuBois Agrinovation – 800-667-6279
- Frecon Orchards Supply – 610-367-2933
- International Paper – 800-222-8984
- Jordan Seeds, Inc. – 651-738-3422
- Martin’s Produce Supplies – 888-381-8641
- Nolt’s Produce Supplies – 717-656-9764, 661-7069
- ProducePackaging.com – 800-644-8729
- Saylor’s Farm Products – 814-745-2306
- Statewide Bag Service – 717-647-2623
- Zook’s Plastic Recovery – 717-656-4422

Direct Marketing Supplies

Farm Market Packaging

- Frecon Orchards Supply – 610-367-2933
- PA Veg. Mktg. & Research Prog. – 717-694-3596
- Ron the Bagman – 717-361-2281
- Statewide Bag Service – 717-647-2623

Advertising and Promotional Materials

- PA Veg. Mktg. & Research Prog. – 717-694-3596
- Practical Promotions – 931-388-4491

**STATEWIDE
BAG
SERVICE**

TOWER CITY, PA 17980

Paper & Poly Bags-Fischbein Sales & Service
Mesh Bags –Carton’s & DRC’s
Thread & Wire Ties
717-647-2623 – 717-460-7962
www.tallmanpotatoes.com
CALL STATEWIDE BAG SERVICE
FOR YOUR
PRODUCE PACKAGING NEEDS
HIGH QUALITY PRODUCTS
&
PERSONALIZED SERVICE
sjtallman@tallmanpotatoes.com



**Frecon
Orchard Supplies**

Stokes Aluminum Tripod Ladders
Produce Packaging, Egg Cartons

Located in Boyertown, PA
 Phone: 610-367-2933

**rockford
package supply**

Dedicated to your success

for 3 Generations.

**SEE YOU AT THE MID-ATLANTIC FRUIT
& VEGETABLE CONVENTION!**

www.rockfordpack.com | 800-444-7225

ProducePackaging.com[®]
for all your produce packaging needs

1-800-644-8729
Kurt Zuhlke & Assoc., Inc.
P.O. Box 609, Bangor, PA 18013



Over 45 Years In The Industry

For over 45 years, Kurt Zuhlke & Assoc., Inc. has been a part of the many innovative packaging concepts utilized by the produce industry.

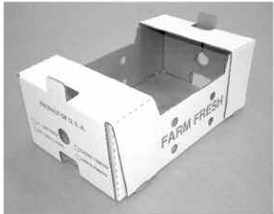

High Quality Products And Services

Our packaging is designed to protect produce, provide excellent visibility to the consumer, reduce shrinkage and enhance the product. We also offer professional labeling design and application.



From Farmers To Repackers

Whether you are ordering a case or a truck load, you can rest assured that we have the ability and capacity to service your orders quickly.



Saylor's Farm Products

*We Also Make Watercaps
For Earlier Tomatoes*



Manufacturers of Agricultural Containers.

www.saylorfarm.com



Saylor's Farm Products

17319 Route 68, Sligo, PA 16255
Phone 814-745-2306
john@saylorfarm.com

R. Davis Enterprises, Inc.

Ron the Bagman

"Goes Green"

*Besides offering high-quality,
made-in-America,
t-shirt shopping bags,
stretch film and
hard-bottom wooden baskets,
now receiving recycled ag
plastics with two drop-off points
in Mount Joy and Shippensburg.*

717-361-2281 office

717-689-0645 cell

RontheBagman@comcast.net

www.RontheBagman.com

VENDORS BY CATEGORY

Greenhouse Supplies & Equipment

Greenhouse Equipment and Supplies

- Blackmore Co. – 800-874-8660
- DuBois Agrinovation – 800-667-6279
- IPM Laboratories – 315-497-2063
- Lambert Peat Moss – 888-632-8808
- Martin's Produce Supplies – 888-381-8641
- Martin's Repair Shop – 717-733-3015
- Marvel, Robert, Plastic Mulch – 800-478-2214
- Nolt's Produce Supplies – 717-656-9764, 661-7069
- Rimol Greenhouse Systems – 603-494-5775
- Second Sun Hydroponics LLC – 717-389-5992
- Zook's Plastic Recovery – 717-656-4422

PEAT MOSS & GROWING MIXES



Jeffrey P. Bishop

Jeff Bishop Sales LLC.

☎ 888-632-8808

lambertpeatmoss@aol.com • www.lambertpeatmoss.com

Ellepot™ Trays

from Blackmore
Get You Growing!

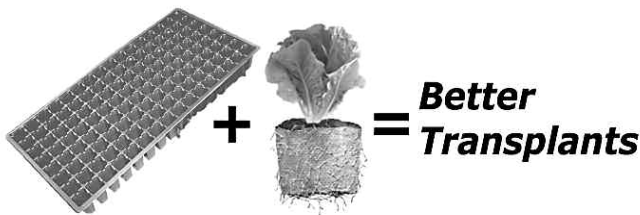

Order your Trays or
Pre-Filled Ellepot™ Trays today!

1-800-874-8660

There is a Blackmore Tray
for every application
and an Ellepot for most tray sizes.



www.blackmoreco.com

Visit us at **Booth 610**
at the Great Lakes Expo
to learn more about the \$399 seeder.

Your Source for . . .

HIGH TUNNELS



Call Ryan Richard @ 302.853.5563
or Email rrichard@rimol.com



Microgreens and Wheatgrass
Supplies



We have seeds, shallow germ trays,
insert packs, and thick humidity domes.

(717) 389-5992 | www.SecondSunHydro.com

BEST QUALITY - EASY PICKUP
FAST SHIPPING OPTIONS

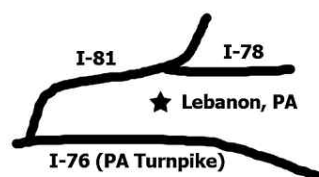

Find Us At:

34 North 16th Street
Unit 5 (Last Green Door on Right)
Lebanon, Pa 17042
Easy Access from
I-81, I-76, & I-78



Kratos

This mighty strong pumpkin has a large, firmly-attached handle, hearty vine, large, medium-ribbed fruit (20-30 lbs), and an excellent, grower-friendly yield.



Zeus

As king of the pumpkins, Zeus features a large, firmly-attached handle and attractive, medium-sized fruit (16-20 lbs), perfect for shipping.



Traveler

This reliable watermelon has a vigorous, strong plant producing blocky fruits of medium-green color with dark-green stripes, a firm, crisp, smooth interior, and high brix.



Respect

This high-quality medium dark green zucchini has a vigorous and open plant for easy picking, good earliness, a high yield of top-grade fruit and a good resistance package.

For more information, call:
Nolts Produce Supply • (717) 656-9764
 152 North Hershey Avenue, Leola, PA 17540-9711

VENDORS BY CATEGORY

Greenhouse Supplies & Equipment

Bedding Plant Seeds/Plugs/Cuttings

Harris Moran Seeds – 209-579-7333
 Harris Seeds – 800-544-7938
 Stokes Seeds – 800-263-7233
 Twilley Seeds – 800-622-7333

Greenhouse and Low/High Tunnel Structures

Beiler Greenhouse Structures – 717-806-0553
 Rimol Greenhouse Systems – 603-494-5775

Small Fruit Supplies

Berry Nurseries

Krohne Plant Farm – 269-424-5423
 Maplewood Produce Greenhouse – 717-732-3278
 Martin's Repair Shop – 717-733-3015
 Nourse Farms, Inc. – 413-665-2658

Vegetable Supplies

Vegetable Plants

Martin's Repair Shop – 717-733-3015
 Seiger's Seeds – 800-962-4999

Vegetable Seeds

Harris Moran Seed Co. – 209-579-7333
 Harris Seeds – 800-544-7938
 Martin's Produce Supplies – 888-381-8641
 Jordan Seeds, Inc. – 651-738-3422
 Nolt's Produce Supplies – 717-656-9764
 Reed's Seeds – 607-753-9095
 Rupp Seeds – 419-337-1841
 SeedWay – 800-952-7333
 Siegers Seed Co. – 800-962-4999, 616-786-4999
 Stokes Seeds – 800-263-7233
 Twilley Seeds – 800-622-7333

Strawberry Plants
Over 20 Leading Varieties • Fall Dug
State Inspected - Grown on Fumigated Sand
Asparagus Crowns
 Leading Varieties • Male Hybrids • Superior Root Systems

Over 20 Years Experience
 All Available In Our Free
 Illustrated Price List
Krohne Plant Farms
 65295 CR 342, Hartford, MI 49057
 Ph: (269) 424-5423
 Fax: (269) 424-3126
www.krohneplantfarms.com

Krohne
 Plant Farms, Inc. 

e-mail: info@krohneplantfarms.com

Since 1932



The

Best Berry Plants

- Strawberries, raspberries, blueberries, blackberries, asparagus and more!
- Where the pros go for plans and plants.
- Call for a free catalog and plasticulture guide!

41 River Road
South Deerfield
Massachusetts 01373



www.noursefarms.com 413.665.2658



STRAWBERRY PLANTS



Taking Orders for Strawberry
Plugs for Aug. & Sept. Planting

Varieties Available:

Chandler • Sweet Charlie
Camarosa • Festival
Radiance • Albion
St. Andreas • Benicia

ORDER NOW FOR
AUGUST PLANTING

Tips are harvested from tissue
cultured plant stock.

Delivery Available

Maplewood Produce Greenhouse

Reuben R. Martin
717-532-3278



Make It A Harvest To Look Forward To!

WWW.SEEDWAY.COM - (800) 952-7333



DIAMONDBACK

DIAMONDBACK - 54 Days
 Strong yields and quality; strong vine vigor. Target Leaf Spot resistance allows for placement in later season slots. Fruit will hold length throughout extended picks. Gynoecious.



MOMENTUM

MOMENTUM - 56 Days
 Momentum sets well in heat and stress conditions and is adapted to most growing areas. Pods are very dark and straight and provide a concentrated set on an upright plant for mechanical harvest.



AWESOME XR

AWESOME XR - 74 Days
 Awesome type with added Rust resistance and more plant vigor. This bicolor Sh2 boasts excellent yield potential. Can be used all season in Northern regions.



YUMMY ORANGE

YUMMY ORANGE - 73 Days
 Apricot-orange fruit is tender-crisp, sugary sweet, and nearly seedless. Keeps well. Good for marketing in clamshells or berry boxes. Great for vegetable trays. Continuous setting, excellent for tunnels.

Our Experienced Sales Representatives Can Help You!

JIM CICALESE (717) 363-0755

PAT LICCIARDELLO (716) 570-1871

Mention PVGA17 when requesting your free catalog, and receive \$5 OFF your first (\$25 or more) order!



TWILLEY
 SEEDS

For LOCAL FRESH PRODUCE Professionals

121 Gary Rd • Hodges, SC 29653
 864-227-5150 • 800-622-7333 • Fax: 864-227-5108
 www.twilleyseed.com

VENDORS BY CATEGORY

Services

Associations

Pennsylvania Association for Sustainable Agriculture
814-349-9856
Pennsylvania Vegetable Growers Association
717- 694-3596

Auctioneers

Pirrung Auctioneers – 585-728-2520

Conservation Stewardship Program

Natural Resources Conservation Program/USDA

Crop Insurance

Morrissey, Bernard, Insurance – 800-422-8335

Financial Services

AgChoice Farm Credit – 800-998-5557
MidAtlantic Farm Credit – 888-339-3334
Stewardship Group – 717-935-5858

General Insurance (Liability, Workers Compensation, Health, Fire, etc.)

Agri-Services Agency – 800-256-4105
Morrissey, Bernard, Insurance – 800-422-8335



JORDAN SEEDS, INC.

6400 Upper Afton Rd.
Woodbury, MN 55125

Phone: (651) 738-3422
(651) 739-9578
Fax: (651) 731-7690

www.jordanseeds.com
seeds@jordanseeds.com

- Bulk Vegetable Seed
- Drip Irrigation Tape & Fittings
- Transplanters
- Plastic Mulches, Layers, & Planters
- Row Covers
- Bags, Baskets, Cartons
- Plastic Containers
- Soiless Mix & Seedling Trays
- Soluble Fertilizer

Catalog Upon Request

Siegers...more than seed

Our extensive selection and consultant's knowledge of varieties benefits you, our valued customer.



GLACIAL

A 76 day with incredible, bright, white kernels that stay white! Big ears with excellent tip fill. Great eating quality.



AMERICAN DREAM

77 Days. Resist./Tol.: Et_{tn}. A Supersweet Bi-Color with high yields, strong tip fill, attractive ear package, and blissful taste. It's the late maturing variety we have all dreamed about.



ANTHEM II

73 Days. Resist./Tol.: Et_{tn}. A bi-color with great eating quality, tender and sweet. Excellent yield and tip fill. Has below ground protection for Corn Rootworm. Proven to have dual modes of action for insect protection against European Corn Borer, Corn Earworm, Fall Armyworm and weed control benefits of Roundup® agricultural herbicides.



Blake Myers
(585) 303-3252
vegetableseeds@aol.com

1-800-962-4999 • www.siegers.com

**SIEGERS
SEED CO.**



CONSTANTLY RAISING THE BAR

**NEW FROM RUPP
FEATURING PMT**
BAYHORSE GOLD *Large*
BISBEE GOLD *Pie*
SKIDOO GOLD *Mid Size*



Kickoff XR is an early high quality bi-color variety from **IFSI**, who is known for bringing varieties with outstanding eating quality.



Cobra is a productive hybrid with an excellent disease package from **US Agriseeds**, a leading provider of top pepper, tomato, and cucumber varieties.



Frederik produces high quality fruit with long shelf life. This greenhouse variety is the latest addition to **Enza Zaden's** protected culture line.



SEE WHAT GOOD YIELDS®

800-700-1199 • ruppseeds.com

Raising the bar — bringing you the best products in partnership with Enza Zaden, IFSI, and US Agriseeds.

Visit ruppseeds.com to request or download your copy of our 2017 catalog including over 50 new products.

VENDORS BY CATEGORY

Services

Government

Pennsylvania Department of Agriculture – 717-705-9511

Produce Auctions

- Buffalo Valley Produce Auction – 570-966-1151
- Countryside Produce Auction
814-662-2222
- Cumberland Valley Produce Auction
717-530-5007
- Kutztown Produce Auction – 610-683-7161
- Lebanon Produce Auction – 717-367-8379
- Leola Produce Auction – 717-656-9592
- Morrison's Cove Produce Auction
814-793-9384
- Oxford Produce Auction – 610-392-2722
- Shippensburg Produce Auction
717-532-5511
- Smicksburg Produce Auction
- Snyder County Produce Auction
570-374-0284
- Sugar Valley Produce Auction
570-725-2000
- Sunnyburn Produce Auction
717-862-3010
- Tri-County Produce Auction
724-946-8540
- Weaverland Produce Auction
717-355-0834

Sales/Brokerage Services

Seminole Produce Distributing – 717-525-8372



The Stewardship Group
Lifting Visions Higher

Insurance, Accounting, Tax,
Retirement & Estate Planning

Farm stewardship and
proper tax preparation
come together at
The Stewardship Group.

*Call Us To Have Your Tax Return
Expertly Prepared*

866.935.5858

www.TheStewardshipGroup.org

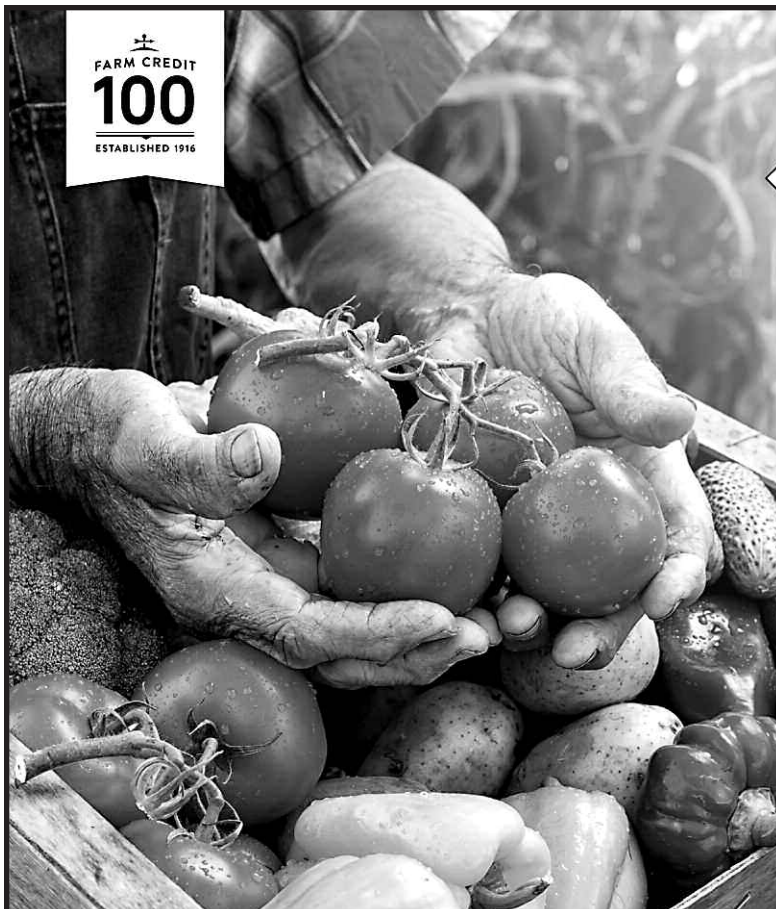

WE'RE HERE FOR YOUR GROWING NEEDS!

You give your plants the proper care to ensure they grow. Do you do the same for your operation? Farm Credit can provide financing for all of your growing needs. We've been helping producers like you for 100 years, and are the experts in our field!

Call today to learn more about all the tools Farm Credit has to help you grow.

 **AgChoice
Farm Credit**
800.998.5557
agchoice.com

 **FARM CREDIT
MIDATLANTIC**
888.339.3334
maf.com



TURN TRAFFIC INTO CUSTOMERS!

Practical Promotions LLC



HUGE 5X20 Just \$199⁰⁰

15 Ft Tall FrontageFlags™ \$33⁰⁰



**Banners, Inflatables
& More!**



www.practicalpromotions.com • 931-388-4491

✓ PA Preferred®

Grown in PA. It makes a difference.

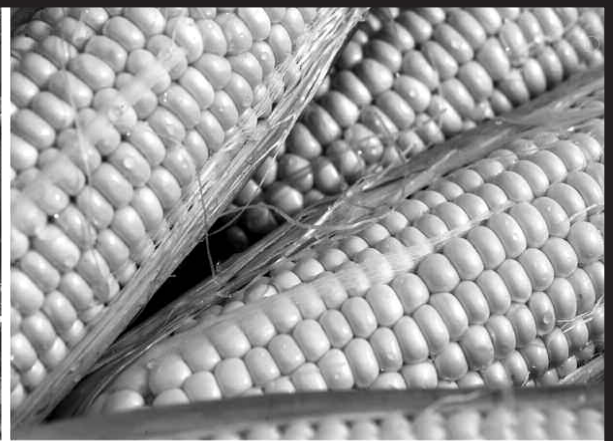

BUY PENNSYLVANIA GROWN FRUITS & VEGETABLES



[pinterest.com /papreferred](https://www.pinterest.com/papreferred)

[@papreferred](https://www.facebook.com/papreferred)

[facebook.com /PAPreferred](https://www.facebook.com/PAPreferred)



VENDORS BY NAME

AgChoice Farm Credit *see ad on page 24*
900 Bent Creek Blvd., Mechanicsburg, PA 17050
888-998-5557
www.agchoicefarmcredit.com

Agri-Services Agency
1008 Applejack Dr., Gibsonia, PA 15044
800-256-4105, fax - 724-449-6336
www.AgServAgency.com

Arctic Refrigeration Co. *see ad on page 10*
26 Cedar St., Batavia, NY 14020
585-343-2678
www.arcticrefrigeration.com

Beiler Greenhouse Structures, LLC
2096 Mine Rd., Paradise, PA 17562
717-806-0553

Blackmore Co. *see ad on page 18*
10800 Blackmore Ave, Belleville, MI 48111
800-874-8660, fax - 734-483-5454
www.blackmoreco.com

Black Rock Repair *see ad on page 8*
858 Pumping Station Rd., Kirkwood, PA 17536
717-529-6553

Buffalo Valley Produce Auction
Violet Road, Mifflinburg, PA 17844
570-966-1151 fax 570-966-2601
www.buffalovalleyproduce.com

Countryside Produce Auction
1695 Savage Rd., Salisbury, PA 15558
814-662-2222

CropCare *see ad on page 9*
295 Wood Corner Rd., Lititz, PA 17543
717-738-7365 fax - 717-738-7375
www.cropcareequipment.com

Cumberland Valley Produce Auction
101 Springfield Rd., Shippensburg, PA 17257
717-530-5007

Dubois Agrinovation, Inc. *see ad on page 13*
478 Notre Dame, St-Remi, Quebec, Canada J0L2L0
800-667-6279
www.duboisag.com

Fertrell Company
PO Box 265 Bainbridge PA 17502-0265
717-367-1566
www.fertrell.com

VEGETABLE FARM EQUIPMENT
AUCTION SPECIALISTS
PIRRUNG AUCTIONEERS, INC.
JAMES P. PIRRUNG
www.pirringinc.com
585-728-2520

*"Serving the Buying - Selling Needs of Farmers
Across America Since 1948"*

**Morrissey Insurance is proud to represent an industry as
hardworking and dedicated as our farmers!**

**We are pleased that our customers choose to work with us!
Customer satisfaction is our number one goal.**

Here's what one of our valued customers has to say when asked:

"Why do you choose to work with Morrissey Insurance?"

"Morrissey is a family owned and operated business that understands the needs of our family farm and retail business. Their staff is very knowledgeable and helpful and can provide us with the various types of insurance our farm and retail business needs to keep us "safe" doing business in the Lehigh Valley. We have been with Morrissey for many years and are very happy with the service they provide."

Newhard Farms



**B&M MORRISSEY
INSURANCE**
"Insuring Your Future since 1971"

890 N. Reading Rd., Ephrata, PA 17522
13025 Route 6, Troy, PA 16947
www.insuringyourfuture.com

800-422-8335

VENDORS BY NAME

- Frecon Orchard Supplies** *see ad on page 16*
501 South Reading Ave., Boyertown, PA 19512
610-367-2933
- Gristmill Vegetable Farm** *see ad on page 12*
201 Gristmill Rd., New Holland PA 17557
717-354-8444 fax – 717-354-8444
- Growers Mineral Solutions**
PO Box 1750
Milon, OH 44846
800-437-4769
- Growth Products** *see ad on page 15*
80 Lafayette Ave., White Plains, NY 10603
800-648-7626
www.growthproducts.com
- Harris Moran Seed Co.** *see ad on page 19*
555 Codoni Avenue, Modesto, CA 95357
209-579-7333 fax - 209-544-0335
www.harrismoran.com
- Harris Seeds**
PO Box 24966, Rochester, NY 14624-0966
800-544-7938
www.harrisseed.com
- Hillside Cultivator** *see ad on page 7*
911 Disston View Dr., Lititz, PA 17543
717-626-6194
www.hillsidecultivator.com
- I & J Manufacturing** *see ad on page 4*
5302 Amish Rd., Gap, PA 17527
717-442-9451
www.farmingwithhorses.com
- International Paper**
342 E. York St., Biglerville, PA 17307
800-222-8984, fax - 717-677-9455
www.internationalpaper.com/US/EN/Business/IPG.htm
- IPM Laboratories**
PO Box 300, Locke, NY 13092-0300
315-497-2063, fax - 315-497-3129
www.ipmlabs.com
- Jordan Seeds, Inc.** *see ad on page 22*
6400 Upper Afton Rd., Woodbury, MN 55125
651-738-3422, fax - 651-731-7690
www.jordanseeds.com
- Kirkwood Produce Auction**
1597 Kirkwood Rd., Kirkwood, PA 17536
717-529-2748
- KoolJet Refrigeration** *see ad on page 12*
1444 Bell Mill Side Rd., Tillsonburg, ON Canada N4G 4G9
866-748-7786 fax – 519-688-5962
www.kooljet.com
- Krohne Plant Farm** *see ad on page 20*
65295 CR 342, Hartford, MI 49057
269-424-5423 269-424-3126
www.krohneplantfarms.com
- Kutztown Produce Auction**
209 Oakhaven Rd., Fleetwood, PA 19522
610-683-7161 fax 610-683-5429
http://theplantauction.com
- Lambert Peat Moss** *see ad on page 18*
106 Lambert Rd., Riviere-Ouelle, QU Canada G0L 2C0
800-463-4083
www.lambertpeatmoss.com
- Lebanon Produce Auction**
2862 Harvest Rd., Elizabethtown, PA 17022
717-367-8379

Imprinted Tee-Shirt Grocery Bags



12" x 7" x 23"
18 microns
PA Preferred logo on reverse side.
\$28 per case of 1,000
Plus shipping (or can be picked up at Mid-Atlantic Convention).

Call 717-694-3596 to order.



INTRODUCING PALRING WOVEN GREENHOUSE COVERS

PALRING 175 UV, AF&IR SHINY

- 7-year industry-leading warranty.
- Woven greenhouse cover for all types of cultivation.
- Extra strength makes it hail and tear-resistant – long lasting.
- UV package of additives assures superior performance and long life.
- IR additives keep foliar temperature higher in the greenhouse during cold nights.
- Anti-drip directs condensation to the cover's edges, reducing the incidence of fungus and disease.
- Shiny finish for increased direct sunlight.
- Can be sewn to insect net and fitted with eyelets.
- Backed by 20 years of manufacturing and engineering experience.

PALRING 146 UV, AF&IR SHINY ALL THE BENEFITS OF PALRING 175 PLUS...

- 7-year industry-leading warranty as a bottom layer under Palring 175.
- 4 year warranty when used as a single layer.



ROBERT MARVEL PLASTIC MULCH, LLC

www.robertmarvel.com

1-800-478-2214



VENDORS BY NAME

Leola Produce Auction

PO Box 307, Leola, PA 17540
717-656-9592

Maplewood Produce Greenhouse *see ad on page 20*

8564 Old Scotland Rd., Shippensburg, PA 17257
717-532-3278

Market Farm Implement *see ad on page 4*

257 Fawn Hollow Rd., Friedens, PA 15541
814-443-1931
www.MarketFarm.com

Martin's Produce Supplies *see ad on page 14*

627 Britton Rd., Shippensburg, PA 17257
888-381-8641 fax - 717-532-5872

Martin's Repair Shop *see ad on page 10*

28 E. Trout Run Rd., Ephrata, PA 17522
717-733-3015, fax - 717-733-9618

Marvel Plastic Mulch-Irrigation, Robert

see ads on pages 11 & 27
2425 Horseshoe Pike, Annville, PA 17003
800-478-2214, fax - 717-838-0978
www.RobertMarvel.com

Mechanical Transplanter Co. *see ad on page 7*

1150 Central Ave., Holland, MI 49423-5230
800-757-5268, fax - 616-396-3619
www.mechanicaltransplanter.com

Messick Farm Equipment

187 Mertz Dr., Elizabethtown 17822
800-222-3373
www.messicks.com

MidAtlantic Farm Credit *see ad on page 24*

45 Aileron Ct., Westminster, MD 21157
888.339.3334
www.mafo.com

Morrison's Cove Produce Auction

174 Windy Acres Ln., Roaring Springs, PA 16673
814-793-9384

Morrissey Insurance Inc., Bernard *see ad on page 26*

890 N. Reading Rd., Ephrata, PA 17522
800-422-8335, fax - 717-336-3729
www.insuringyourfuture.com

Nolt's Produce Supplies *see ads on pages 6, 13 & 19*

152 North Hershey Ave., Leola, PA 17540
717-656-9764

Nourse Farms, Inc. *see ad on page 20*

41 River Rd., South Deerfield, MA 01373
413-665-2658, fax - 413-665-7888
www.noursefarms.com

Nutri-Cal / CSI Chemical Corp.

10980 Hubbell Ave., Bondurant, IA 50035
800-247-2480
www.nutri-cal.com

Oxford Produce Auction

200 Union School Rd., Oxford, PA 19363
610-392-2722

Penns Creek Welding & Manufacturing *see ad on page 12*

1340 Broadway Road, Winfield, PA 17889
570-837-1197
www.pennscreekwelding.com

Penna. Department of Agriculture

see ads on pages 25 and 29
2301 N Cameron St., Harrisburg, PA 17110-9408
717-705-9511
www.pda.state.pa.us

PA Preferred Program *see ad on page 25*

2301 N Cameron St., Harrisburg, PA 17110-9408
717-772-3094
www.papreferred.com

Penna. Ass'n. for Sustainable Ag.

PO Box 419, Millheim, PA 16854
814-349-9856, fax - 814-349-9840
www.psafarming.org

Penna. Vegetable Marketing and Research Program

2301 N. Cameron St., Harrisburg, PA 17110
717-694-3596
www.paveggies.org

Perdue AgriRecycle

28338 Enviro Way, Seaford DE 19973
302-628-2361 fax 302-628-7943
www.perdueagrireecycle.com

Pirring Auctioneers, Inc. *see ad on page 26*

PO Box 607, 2731 East Naple Street, Wayland, NY 14572
585-728-2520, fax - 585-728-3378
www.pirringinc.com

Practical Promotions *see ad on page 25*

1586 Groveland Ridge Rd., Columbia, TN 38401
931-388-4491 fax - 931-368-4926
www.practicalpromotions.com

ProducePackaging.com *see ad on page 17*

PO Box 609, 20 Market St., Bangor, PA 18013
800-644-8729
www.producepackaging.com

Rain-Flo Irrigation *see ad on page 5*

929 Reading Rd., East Earl, PA 17519
717-445-3000, fax - 717-445-8304
www.rainfloirrigation.com

Rimol Greenhouse Systems *see ad on page 18*

40 London Derry Tpk., Hooksett, NH 03106
603-494-5775, fax - 603-629-9023
www.rimol.com

Rockford Packaging *see ad on page 16*

10421 Northland Dr., Rockford, MI 49341
800-444-PACK
www.rockfordpack.com

Ron the Bagman *see ad on page 17*

1909 Cloverleaf Rd., Mt. Joy, PA 17552
717-361-2281

Rupp's Seeds *see ad on page 23*

17919 Road B, Wauseon, OH 43567
419-337-1841, fax - 419-337-5491
www.ruppseeds.com

Saylor's Farm Products *see ad on page 17*

17319 Rt 68, Sligo, PA 16255
814-745-2306
www.saylorsfarm.com

Second Sun Hydroponics, LLC *see ad on page 18*

1594 Cumberland Street Suite 276, Lebanon PA, 17042
717-389-5992
www.SecondSunHydro.com

SeedWay *see ad on page 21*

1225 Zeager Rd., Elizabethtown, PA 17022
800-952-7333, fax - 717-367-0387
www.seedway.com

Seminole Produce Distributing Inc.

PO Box 4521, Sanford, FL 32772
407-322-7785 or 717-525-8372
www.freshveggie.com



pennsylvania
DEPARTMENT OF AGRICULTURE

Is your risk management plan good enough?

1. Figure out the safety net you need.

- What do you plan to grow?
- What are your input costs?
- What's your expected revenue?

2. Seek farm bill options and advice from:

- crop insurance agents,
- your county FSA office, and/or
- Penn State Extension.

3. Choose the best options.

Find a crop insurance agent at www.cropinsurancePA.com.



717.787.6901 | keepPAgrowing.com

GENERAL

PVGA Membership and Mid-Atlantic Fruit & Vegetable Convention Registration Form

Name _____
 Farm Name _____
 Address _____
 City/State _____ Zip Code _____
 PA County _____ Telephone ____/____/____ Cell Phone ____/____/____
 Facsimile ____/____/____ Electronic Mail _____

Business Information Please check all that apply.
 Grower (owner-operator) Retail Wholesale
 Fresh Market Vegetables Processing Vegetables Greenhouse Vegetables Potatoes
 Small Fruit Bedding Plants Cut Flowers Tree Fruit/Wine Grapes
 Grower Employee Supplier (equipment, chemicals, etc.) Processor Other _____

2017 PVGA Membership Dues

Regular Membership Dues increase to \$55 after February 2. \$50.00 _____
 Open to all owner, operators and employees of vegetable, potato and berry farm operations, processing firms and supply companies. All memberships include newsletter subscription.
Associate Regular Membership Includes newsletter subscription. \$30.00 _____
 Must be one of the following - circle one: Student Retired University Staff Extension Agt.
Keystone Membership An optional membership category open to vegetable and berry farming operations, processing firms, and supplier firms. Includes newsletter subscription. _____
 Dues based on gross income from vegetable potato or berry industries. Any member paying \$75 or more in dues will be considered a Keystone Member. The following rates are only suggestions.
 \$75 for up to \$75,000 \$100 for \$75,000 to \$150,000 \$150 for \$150,000 to \$225,000
 \$200 for \$225,000 to \$500,000 \$275 for \$500,000 to \$1,000,000 \$375 for over \$1,000,000
Associate Keystone Membership Must be a family member or employee of a Keystone Member. \$30.00 _____

2017 Mid-Atlantic Fruit and Vegetable Convention

REGISTRATION IS REQUIRED FOR EACH PERSON, including spouses. Registration fees allow one to attend both fruit and vegetable sessions as well as enter the exhibit area. Each registrant also receives a copy of the Proceedings. Students and children 16 and under receive free registration. No refunds of pre-registration fees will be made unless canceled by January 27 in writing, by phone (717-694-3596) or by email (pvga@pvga.org). No confirmation will be mailed prior to the Convention.

PLEASE LIST THE NAME OF EACH PERSON ATTENDING (for use in preparing nametags)

Member Registration one fee whether you are attending for 1, 2 or 3 days - per person
 Advance for the first person from a family, farm or business (\$80 after Jan. 23) _____ @ \$65.00 _____
 Advance for additional persons from a family, farm or business (\$80 after Jan 23) _____ @ \$60.00 _____

Non - Member Registration - (family and employees of PVGA members will be admitted at the above member's rates.)
 One Day per person _____ @ \$110.00 _____
 Three Day includes registration for 2 or 3 days per person. _____ @ \$150.00 _____

Student /Children Registration for students and children 16 and under only _____ @ no charge

Workshops/Tour **PRE-REGISTRATION IS REQUIRED FOR THESE EVENTS.** *please indicate who will be attending below*

Hops Production – Jan 30 (with lunch) *names* _____ @ \$90.00 _____
 PA Pesticide App Training – Jan 30 (with lunch) *names* _____ @ \$60.00 _____
 FSMA Grower Training - Jan 30 (with lunch) (\$150 for non-PA growers) _____ @ \$50.00 _____
 Recall Readiness – Jan 30 (no lunch) *names* _____ @ \$20.00 _____
 Greenhouse Vegetable Prod. – Jan. 30 (with lunch) *names* _____ @ \$60.00 _____
 Vegetable Grafting – Jan 30 (no lunch) *names* _____ @ \$30.00 _____
 YGA Hands-on Apple Tree Grafting – Jan 30 (no lunch) *names* _____ @ \$65.00 _____
 Cider Symposium - Jan. 30 (with lunch) *names* _____ @ \$160.00 _____
 Farm Market Bus Tour – Jan. 30 *names* _____ @ \$60.00 _____

Meals Annual Growers Dinner – January 31 _____ @ \$35.00 _____

Proceedings Registration includes a **free copy** (\$15 if picked up at the Convention) _____ @ \$20.00 _____

Country Folks Grower -Check here to receive a free monthly subscription to this publication _____

Total Enclosed Payment by check or money order only - make checks payable to "PVGA" _____

Mail this registration form and payment to: PVGA, 815 Middle Road, Richfield, PA 17086-9205 717-694-3596 - phone and fax

VENDORS BY NAME

Shippensburg Produce Auction

1120 Ritner Hwy., Shippensburg, PA 17257
800-346-2334

Siegers Seed Co. *see ad on page 22*

13031 Reflections Dr., Holland, MI 49464
800-962-4999, 616-786-4999, fax - 616-994-0333
www.siegers.com

Smicksburg Produce Auction

1526 Barnard Rd., Smicksburg, PA 16256

Snyder County Produce Auction

6130 S. Susquehanna Trail, Port Trevorton, PA 17864
570-374-0284 fax 570-374-0693
www.snydercountyproduce.com

Stand'N Plant *see ad on page 4*

95 Rose Rd., Saltsburg, PA 15681
724-639-3965 or 724-349-5167
www.standnplant.com

Statewide Bag Service *see ad on page 16*

31 Schwalm Road, Tower City PA 17980
717-647-2623
www.tallmanpotatoes.com

Stauffer Engine and Equipment, Wes

see ad on page 6
23 Pleasant Valley Rd., Ephrata, PA 17522
717-738-4215
www.wesstauffer.com

The Stewardship Group *see ad on page 24*

4417 E Main St., PO Box 911
Belleville, PA 17004
717-935-5858
www.TheStewardshipGroup.org

Stokes Seeds

Box 548, Buffalo, NY 14240
800-263-7233, fax - 888-834-3334
www.stokeseeds.com

Sugar Valley Produce Auction

702 South Mill St., Loganton, PA 17747
570-725-2000

Sunnyburn Produce Auction

101 Atkins Rd., Airville, PA 17302
717-862-3010

Swihart Sales Co. *see ad on page 8*

7240 County Rd AA, Quinter, KS 67752
800-864-4695/785-754-3513,
fax - 785-754-3634
www.swihart-sales.com

Tew Manufacturing Corp. *see ad on page 10*

PO Box 87, 470 Whitney Rd.
Penfield, NY 14526
800-380-5839, fax 585-586-6083

Timac Agro USA *see ad on page 31*

PO Box 888, Reading, PA 19607-0888
800-545-5474
www.timacusa.com

Toro Micro-Irrigation

1588 N. Marshall Ave.,
El Cajon, CA 92020
757-710-0320
www.toromicroirrigation.com

Tri-County Produce Auction

3238 State Route 208
New Wlimington, PA 16142
724-946-8540

Twilley Seeds *see ad on page 21*

121 Gary Rd., Hodges, SC 29653
800-622-7333 fax - 864-227-5108

Weaverland Produce Auction

485 Quarry Rd., New Holland, PA 17557
717-355-0834

Woodhouse Co., J. S. *see ads on pages 7 & 9*

572 Industrial Dr., Lewisberry PA 17339
717-938-5100 fax - 413-732-3786
www.jswoodhouse.com

Zook's Plastic Recovery

183 S. Farmersville Rd., Leola PA 17540
717-656-4422 fax - 717-656-9615
www.zooksplastic.com



Timac AGRO

USA

"Think Different...Farm Better."



6 ANALYSIS AVAILABLE:

15-0-9 20 CaO
KSC mix (Mg and high micros)
14-40-5 micros
0-32-40 micros
14-12-14 micros
8-16-42 micros

The ideal choice for highly soluble, uniform blends



FERTILEADER®

Foliar biostimulant line to maximize growth



FERTIACTYL®

Root biostimulant line to enhance performance

**Leaders in
HIGH PERFORMANCE,
SUSTAINABLE AGRICULTURE.**

For More Information
Call Us at 1-800-545-5474
NEW DEALERS WANTED!

EARLY ORDER DISCOUNTS AVAILABLE.

Pennsylvania Vegetable Growers Association
815 Middle Road
Richfield, Pennsylvania 17086-9205
717-694-3596
pvga@pvga.org
www.pvga.org

PRESORTED
STANDARD
U.S. POSTAGE
PAID
MIDDLEBURG PA 17842
PERMIT NO. 26

Change Service Requested



Pennsylvania Vegetable Growers Association

An association of commercial vegetable, potato and berry growers.

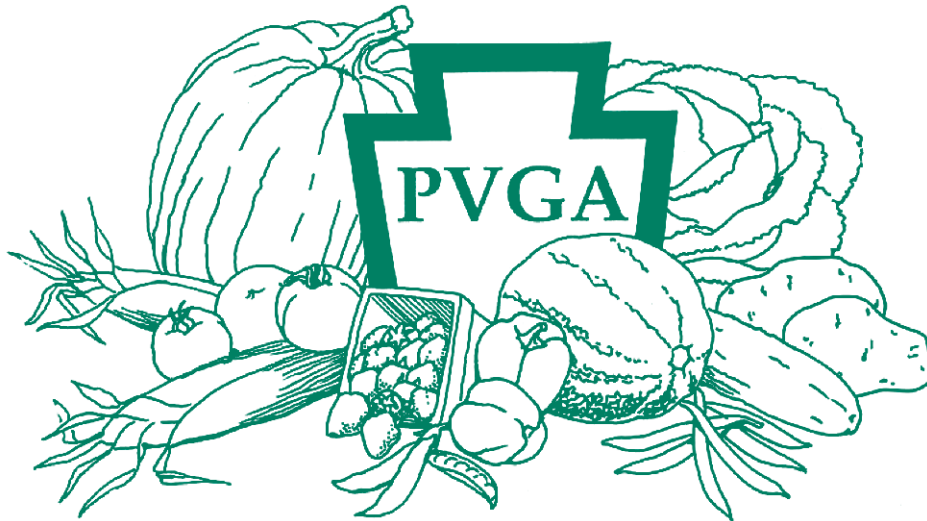

Serving Growers for 90 Years
1926 - 2016

"If you do not receive this newsletter each month, then you are not a member of the Association that is making history serving the Growers of Pennsylvania.

See pages 2 and 30 to join today!"